



TELEDYNE TEST TOOLS
Everywhereyoulook™

DC Power Supply Users Manual

T3PS13206P

T3PS23203P

T3PS33203P

T3PS43203P

This manual contains proprietary information, which is protected by copyright. All rights are reserved. No part of this manual may be photocopied, reproduced or translated to another language without prior written consent of Teledyne LeCroy company.

The information in this manual was correct at the time of printing. However, Teledyne LeCroy continues to improve products and reserves the rights to change specification, equipment, and maintenance procedures at any time without notice.

Table of Contents

SAFETY INSTRUCTIONS	5
Safety Symbols	5
Safety Guidelines	6
Power cord for the United Kingdom	8
OVERVIEW	9
Introduction	10
Key Features	13
Front Panel	15
Rear Panel	22
Constant Voltage/Constant Current Crossover Characteristics	24
GETTING STARTED	25
Start Up	26
Load Connection	27
Turning the Output On/Off	28
BASIC OPERATION	29
Display Change	30
Source Function	33
Load Function	42
Sequence Function	46
Delay Function	57
Monitor Function	66
Recorder Function	69
External I/O Control	72
FILE OPERATION	76
Save/Recall	77
Restore Factory Default Settings	80







SYSTEM SETTINGS	81
System Information	82
System Settings	83
Firmware Upgrading	85
Description of Using Flash Drive	86
REMOTE CONTROL	87
Connection Usage.....	88
Command Syntax	96
Command List	100
Command Details	107
SCPI Status Registers SCPI	178
Errors	188
APPENDIX	192
Replacing the Fuse.....	192
Specifications	193

SAFETY INSTRUCTIONS

This chapter contains important safety instructions that you must follow during operation and storage. Read the following before any operation to insure your safety and to keep the instrument in the best possible condition.

Safety Symbols

These symbols may appear in the manual or on the instrument.

	WARNING	Warning: Identifies conditions or practices that could result in injury or loss of life.
	CAUTION	Caution: Identifies conditions or practices that could result in damage to the T3PSX3200P Series or to other properties.
		DANGER High Voltage
		Attention Refer to the Manual
		Protective Conductor Terminal
		Earth (ground) Terminal
		Do not dispose electronic equipment as unsorted municipal waste. Please use a separate collection facility or contact the supplier from which this instrument was purchased.

Safety Guidelines

General Guideline



- Do not place any heavy object on the unit.
- Avoid severe impact or rough handling that leads to damaging the unit.
- Do not discharge static electricity to the unit.
- Do not block the cooling fan opening.
- Do not perform measurements on circuits that are directly connected to mains power.
- Do not connect the measuring terminals of the unit directly to supply mains.

Note: Measuring terminals of the T3PSX3200P series have no rated measurement category (CAT) per IEC/EN 61010-1:2010.

Power Supply



- AC Input voltage range:
100V/120V/220V/230V $\pm 10\%$
- Frequency: 50Hz/60Hz
- To avoid electrical shock connect the protective grounding conductor of the AC power cord to an earth ground.

Fuse



- Fuse type: 100V/120V : T6.3A/250V,
220V/230V : T3.15A/250V
- To prevent fire, replace the fuse only with the specified type and rating.
- Disconnect the power cord before replacing the fuse.
- Make sure the cause of fuse blowout is fixed before replacing the fuse.

Cleaning the power supply

- Disconnect the power cord before cleaning the power supply.
- Use a soft cloth dampened in a solution of mild detergent and water. Do not spray any liquid

into the power supply.

- Do not use chemicals containing harsh products such as benzene, toluene, xylene, and acetone.

Operation Environment

- Location: Indoor, no direct sunlight, dust free, almost non-conductive pollution (Note below)
 - Relative Humidity: < 80%
 - Altitude: < 2000m
 - Temperature: 0°C to 40°C
-

(Pollution Degree) EN 61010-1:2010 specifies pollution degrees and their requirements as follows. The T3PSX3200Pseries falls under degree 2.

Pollution refers to “addition of foreign matter, solid, liquid, or gaseous (ionized gases), that may produce a reduction of dielectric strength or surface resistivity”.

- Pollution degree 1: No pollution or only dry, non-conductive pollution occurs. The pollution has no influence.
 - Pollution degree 2: Normally only non-conductive pollution occurs. Occasionally, however, a temporary conductivity caused by condensation must be expected.
 - Pollution degree 3: Conductive pollution occurs, or dry, non-conductive pollution occurs which becomes conductive due to condensation which is expected. In such conditions, equipment is normally protected against exposure to direct sunlight, precipitation, and full wind pressure, but neither temperature nor humidity is controlled.
-

Storage environment

- Location: Indoor
 - Relative Humidity: < 70%
 - Temperature: -10°C to 70°C
-

Checking the AC Voltage



CAUTION

Before the power is turned on, confirm that the input power supply meets the following conditions:
 100V/120V/220V/230V ±10% ,
 50/60Hz

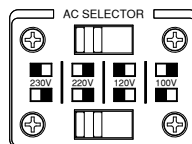

Power cord for the United Kingdom

When using the power supply in the United Kingdom, make sure the power cord meets the following safety instructions.

NOTE: This lead/appliance must only be wired by competent persons



WARNING: THIS APPLIANCE MUST BE EARTHED

IMPORTANT: The wires in this lead are coloured in accordance with the following code:

Green/ Yellow:	Earth
Blue:	Neutral
Brown:	Live (Phase)



As the colours of the wires in main leads may not correspond with the coloured marking identified in your plug/appliance, proceed as follows:

The wire which is coloured Green & Yellow must be connected to the Earth terminal marked with either the letter E, the earth symbol \oplus or coloured Green/Green & Yellow.

The wire which is coloured Blue must be connected to the terminal which is marked with the letter N or coloured Blue or Black.

The wire which is coloured Brown must be connected to the terminal marked with the letter L or P or coloured Brown or Red.

If in doubt, consult the instructions provided with the equipment or contact the supplier.

This cable/appliance should be protected by a suitably rated and approved HBC mains fuse: refer to the rating information on the equipment and/or user instructions for details. As a guide, a cable of 0.75mm² should be protected by a 3A or 5A fuse. Larger conductors would normally require 13A types, depending on the connection method used.

Any exposed wiring from a cable, plug or connection that is engaged in a live socket is extremely hazardous. If a cable or plug is deemed hazardous, turn off the mains power and remove the cable, any fuses and fuse assemblies. All hazardous wiring must be immediately destroyed and replaced in accordance to the above standard.

O VERVIEW

This chapter contains a brief introduction to T3PSX3200P series including the main features and an overview of the front and rear panel. Use the Getting Started chapter on page 25 for start up instructions and how to setup the appropriate operation environment.



Introduction	10
Key Features	13
Front Panel.....	15
Rear Panel	22
Constant Voltage/Constant Current Crossover Characteristics	24

Introduction

Overview The T3PSX3200P series regulated DC power supply series are light weight, adjustable, multifunctional work stations. The T3PS13206P has a 1 independent adjustable voltage outputs with sense. The T3PS23203P has a 2 independent adjustable voltage outputs. The T3PS33203P three independent outputs: two with adjustable voltage levels and one with fixed level selectable from 1.8V, 2.5V, 3.3V and 5V. The T3PS43203P has four independent voltage outputs that are all fully adjustable.

The T3PSX3200P series can be used for logic circuits where various output voltage or current are needed, and for tracking mode definition systems where plus and minus voltages with insignificant error are required.

Independent / Tracking Series / Tracking Parallel The three output modes of T3PSX3200P series, independent, tracking series, and tracking parallel, can be selected through pressing the TRACKING key on the front panel. In the independent mode, the output voltage and current of each channel are controlled separately. The isolation degree, from output terminal to chassis or from output terminal to output terminal, is 500V.

In the tracking modes, both the CH1 and CH2 outputs are automatically connected in series or parallel; no need to connect output leads. In the series mode, the output voltage is doubled; in the parallel mode, the output current is doubled.

Load Mode The T3PSX3200P series models have additional Load function on both CH1 & CH2 with 3 modes: CV (Constant Voltage), CC (Constant Current) and CR (Constant Resistance), all of which can be selected through the function keys on the front panel. Voltage, current and resistance can be well regulated in each mode, respectively.

**Constant Voltage/
Constant Current** Each output channel works in constant voltage (CV) or constant current (CC) mode. Even at the maximum output current, a fully rated, continuously adjustable output voltage is provided. For a big load, the power supply can be used as a CV source; while for a small load, a CC source. When in the CV mode (independent or tracking mode), output current (overload or short circuit) can be controlled via the front panel. When in the CC mode (independent mode only), the maximum (ceiling) output voltage can be controlled via the front panel. The power supply will automatically cross over from CV to CC operation when the output current reaches the target value. The power supply will automatically cross over from CC to CV when the output voltage reaches the target value. For more details about CV/CC mode operation, see page 24.

Automatic tracking mode The front panel display (CH1, CH2) shows the output voltage or current. When operating in the tracking mode, the power supply will automatically connect to the auto- tracking mode.

Display Change Function The T3PSX3200P series provides up to 7 display types, each of which can be selected via setting. For details, see page 29.

Output Waveform Function Under Source mode of the T3PSX3200P series, user can customize a certain V/I sequential waveform output. Under Load mode, it is programmable for dynamic load (below 1Hz). For details, see page 33.

Remote Control To meet the various needs of customers, the T3PSX3200P series is designed for USB and LAN remote control. For details, see page 87.

Additional Function Control signal via external switch is available for user. For details, see page 72.

Key Features

Features	<ul style="list-style-type: none"> • Multiple Outputs: <ul style="list-style-type: none"> T3PS13206P: 32V/6A x 1 T3PS23203P: 32V/3A x 2 (CH1/CH2) T3PS33203P: 32V/3A x 2 (CH1/CH2) <ul style="list-style-type: none"> 1.8V/2.5V/3.3V/5V/5A x 1(CH3) USB Port Output: 3A T3PS43203P: 32V/3A x 2 (CH1/CH2) <ul style="list-style-type: none"> 5V/1A x 1(CH3), 15V/1A x 1 (CH4) • Constant voltage and constant current operation (CV/CC). • Low noise, thermostatically controlled fan. • 4.3 inch TFT display.
Operation	<ul style="list-style-type: none"> • Digital panel control. • Output on/off control (ON/OFF), and each channel can be controlled separately. • Digital voltage and current settings. (Key & Encode) • 10 groups of save/recall settings and 2 groups of power-on settings. <ul style="list-style-type: none"> 10 groups of save/recall Sequence. 10 groups of save/recall Delay. 10 groups of save/recall Record. • CH1/CH2 workable in Load Mode • 7 types display modes available with 5 contents and 2 waveforms respectively • Input/Output terminal (Control I/O) • Alarm buzzer (BEEP). • Key lock function (LOCK). • Multiple remote control interfaces (standard: RS232, USB and LAN)

- | | |
|---------------------|---|
| Protection Features | <ul style="list-style-type: none">• Overvoltage and overcurrent protection (OVP/OCP)• Overtemperature protection (OTP).• Polarity Reverse Protection• Overload Protection (OPP in Load mode) |
| Interface | <hr/> <ul style="list-style-type: none">• Remote Control RS-232• USB remote control• Control I/O• LAN remote control |

Front Panel

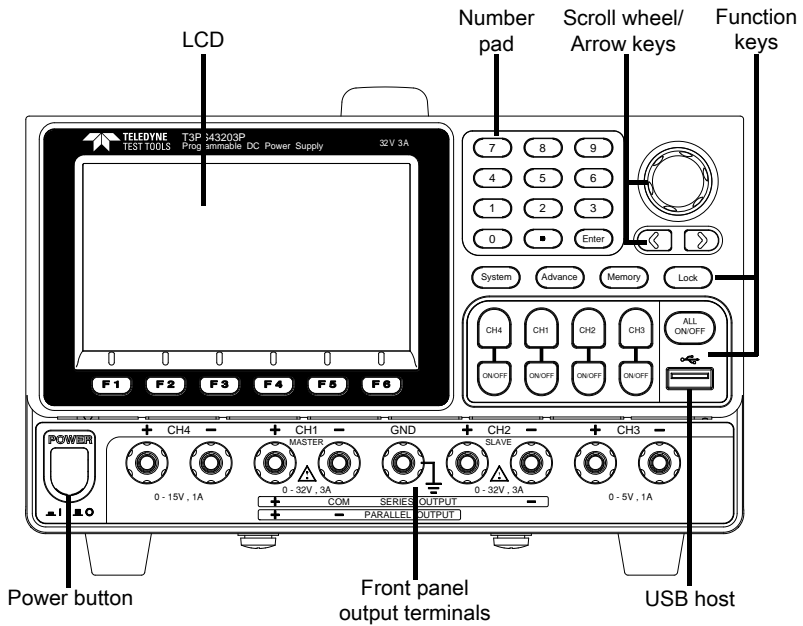

*The panel above is the example of T3P543203P. For other models, refer to page 21

Display

Display Interface



T3P543203P model

Channel distribution Channel number and distribution vary by models with different colors identifications:
 CH1: **Yellow** CH2: **Blue** CH3: **Pink** CH4 : **Green**
 CH1 is master and CH2 becomes yellow under tracking series and tracking parallel modes.

Single channel display

Channel/Status — ② CV — Voltage display
 Power display — 000.00 W 0.0000 A — Current display
 V/I setting — Vset 05.000 OVP 34.0 — OVP/OCP setting area
 Iset 1.0000 OCP 3.30

Channel no. Color of channel remains the original ① when not being set.

Color of channel blinks between the original and orange ① ↔ ① when being set.

Channel status Display active channel state

Power supply: CH1/CH2/CH3/CH4: green **CV** or red **CC**

Load Mode: CH1/CH2: orange **CV CC CR**

Voltmeter Indicators Displays the output voltage with up to 6 digits of resolution. The default units are Volts (V).

CH1: **00.0000 V**

CH2: **00.0000 V**

CH3: **00.0000 V** (T3PS43203P)

1.8 V (T3PS33203P)

CH4: **00.0000 V**

Ammeter Indicator Displays the output current with up to 5 digits of resolution. The default units are ampere (A).

CH1: 

CH2: 

CH3:  (T3PS43203P)

CH4: 

Setting Display Displays the voltage and current settings.

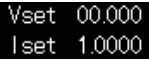
CH1/CH2/CH3/CH4: 

CH3(T3PS33203P) displays setting of voltage only

Display OVP/OCP settings

CH1/CH2/CH3/CH4: 

The CH3 OVP of T3PS33203P is a fixed value (approx. 5.5V), non-configurable and with only on or off switch available for user. OCP is available only for USB output port (approx. 3.1A)



Status Indicator

Display the set function/remote control interface





CH1: The active channel under setting status

OTP: The status of OTP protection mode



: The status of USB flash drive connected

: USB remotely disconnected





: USB remotely connected

: The status of control I/O connected

Others: when operating in the series/parallel tracking mode, the corresponding SER/PAR icons appear on the display.

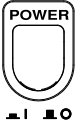
when Sequence/Delay/Monitor/Recorder is activated, the corresponding SEQ/DLY/MON/REC icons appear on the display.

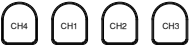
Function Keys

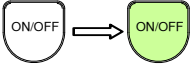
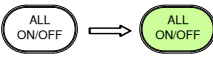
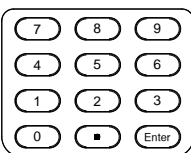
- Power Button**
- 
- Turns the power on or off.
On: 
Off: 
- Channel select buttons**
- 
- Each channel has its own button and promptly switchable among CH1-CH4 setting.
- Output buttons Individual output**
- 
- The ON/OFF button is operational individually by each channel. The Output key will light up when the output is on.
- ON: 
- Output all**
- All ON: 
- Number pad**
- 
- For parameter value setting

Scroll wheel &
Arrow keys

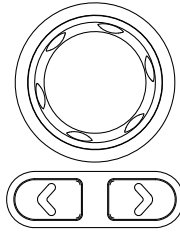

Scroll wheel is used to set each parameter value, whilst arrow keys are used for parameter, menu selection and voltage/current fine adjustment. It is used to switch or operate the displayed waveforms under diagram display mode.

Function keys



The 6 function keys (F1-F6) display varied functions per different operations.

System key



It is used to set functions including Interface, Beep, Backlight, etc. For details, refer to page 83.

Advance key



It is used for certain advanced functions like Sequence, Delay, Monitor, Recorder, etc.

Memory key



It is used to operate several functions including save and recall, etc., for set parameters. For details, refer to page 76.

Lock key



It is used to disable all the panel keys except for the Output key.

Unlock Press the F6 button to unlock, which can disable remote control and return to panel operation.

Terminals

CH1 terminal  Power output terminal or load input terminal

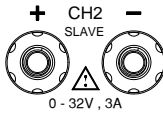
CH2 terminal  Power output terminal or load input terminal

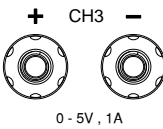
CH3 terminal  Power output terminal

 Power output terminal (T3PS33203P only)

 **Warning** The output current from the 2 terminals should Not exceed 5A for T3PS33203P.

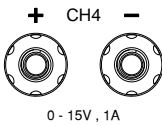
CH4 terminal  Power output terminal

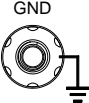
GND terminal  Ground terminal

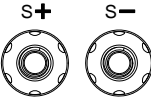
Voltage feedback terminal (SENSE)  Sense terminal of power output (for T3PS13206P only)

Panels of other models:

T3PS13206P

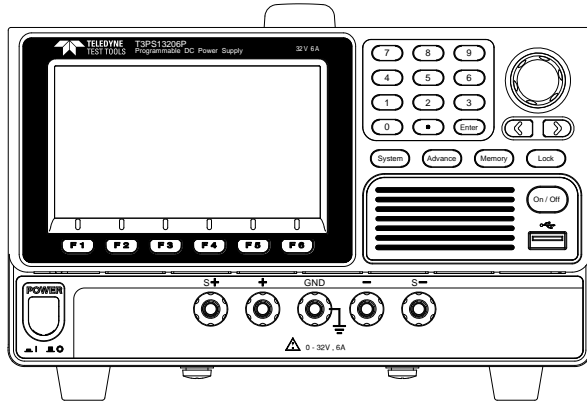

T3PS23203P

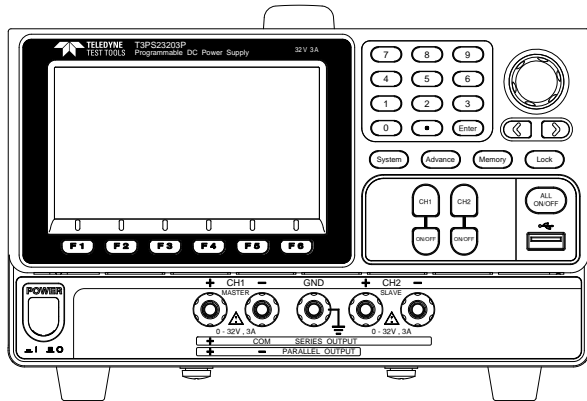

T3PS33203P

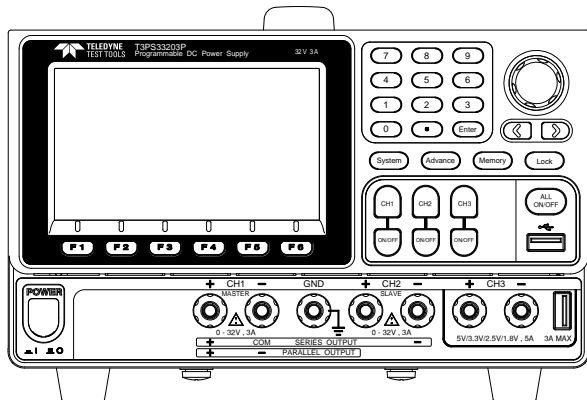

Rear Panel

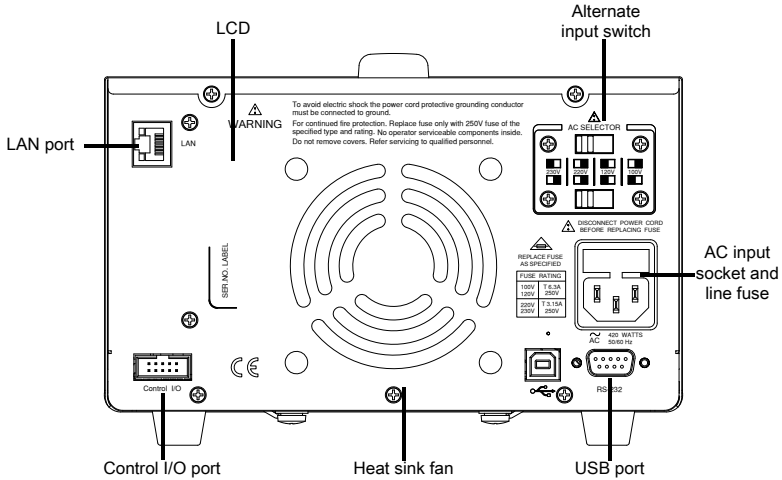

Item	Description
------	-------------

Alternate input switch

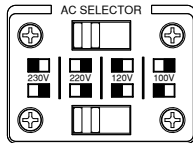

AC voltage selection:
100V/120V/220V/230V $\pm 10\%$,
frequency 50/60Hz

AC input socket and line fuse

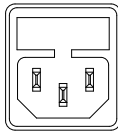

The AC input accepts 100V/120V/220V/230V AC. The frequency is 50Hz/60Hz.
Fuse: 100V/120V: T6.3A/250V,
220V/230V: T3.15A/250V,
slow-blow type, See page 192 for details.

USB port



USB device port for remote control. See page 89 for details.

LAN port



LAN port for remote control. See page 91 for LAN setting and operation details.

RS 232 port

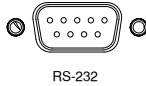

RS232 port for remote control. See page 88 for details.

Control I/O port

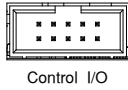

5 ports in all for input/output control. See page 72 for details of configuration.

Constant Voltage/Constant Current Crossover Characteristics

Background The unit will switch automatically between constant voltage and constant current according to changes in the load.

CV mode When the load current is less than the current setting, the unit operates in constant voltage mode, changing the current level according to the load but maintaining the set voltage level until the current reaches the set current level. The status indicator will show CV on the LCD when in CV mode.

Constant Current Mode When the output current reaches the set current level, the unit switches operation to constant current mode. The status indicator will show CC on the LCD display. In CC mode, the current level is maintained and the voltage level is limited to less than the set voltage level to limit the output power from an overload. When the current drops below the set current level, the unit will revert back to CV mode.

Diagram

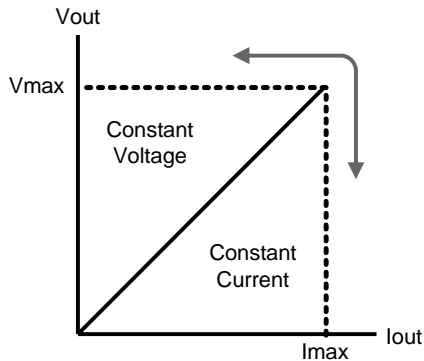

GETTING STARTED

This chapter describes the start up procedures and the preparation that is necessary before operating the power supply.

Start Up.....	26
Load Connection	27
Turning the Output On/Off	28

Start Up

Checking the AC Voltage



CAUTION

Before the power is turned on, confirm that the input power supply meets the following conditions:
 100V/120V/220V/230V $\pm 10\%$,
 50/60Hz

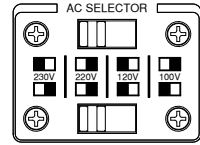

Connecting the AC power cord

The fuse is a slow-blow fuse.
 3.15A (220V/230V)
 6.30A (100V/120V), Confirm that the fuse is of the correct type and rating before connecting the power cord.

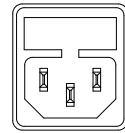

Turning the power on

Press the power button. The LCD will display the line frequency of the AC power supply.



Turning the power off

To turn the power off, press the power button again.



Load Connection

Recommended Cables	Model	Specification	Usage
	GTL-104A	10A	Front panel terminal
	GTL-105A	3A	Sense (for T3PS13206P only)

Front panel wiring

Use the GTL-104A cables for the front panel source connections.

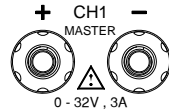

USB Type A only
(Greater than 4A)

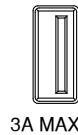

Use the GTL-105A cables for the sense connections.

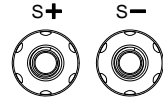

Wire Gauge

Load wires must have enough current capacity to minimize cable loss and load line impedance. Voltage drop across a wire should not exceed 0.5V. The following list is the wire current rating at 450A/cm².

Wire Size(AWG)	Maximum Current (A)
20	2.5
18	4
16	6
14	10
12	16

Turning the Output On/Off

Panel Operation

Press the *Output* key of each channel individually to turn the output on. The Output key will light-up when the output is on.

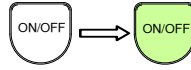

When the output is turned on, pressing the *Output* key again will turn the output off.

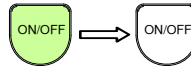

Press ALL ON/OFF key when it needs to output or turn off all channels simultaneously.

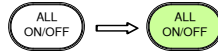

Command Set

Refer to page 100 for more details on remote commands chapter.

Automatic Output Shut Down

Any of the following actions will cause the output to be automatically shut down:

- Toggle between power output and load mode
- Independent/Tracking Series/Tracking Parallel operation
- Recall the saved setting
- OVP/ OCP/OPP/OTP protection is tripped.
- When Sequence/Delay/Monitor/Control IO fits the set conditions.

BASIC OPERATION

This chapter describes how to set various functions.

Display Change	30
Display Area	30
Diverse display screens	30
Source Function	33
Independent Output Mode	37
Tracking Series and Tracking Parallel Modes	39
Load Function	42
Sequence Function	46
Set Sequence Output	46
Set Group Parameter	48
Construct Templet	50
Menu Tree	52
Save and Recall	54
Delay Function	57
Set Delay Output.....	57
Set Group Parameter	59
Menu Tree	61
Save and Recall	64
Monitor Function	66
Set Monitor	66
Recorder Function.....	69
Set Recorder.....	69
Enternal I/O Control	72
Key Function Description	73

Display Change

Display Area

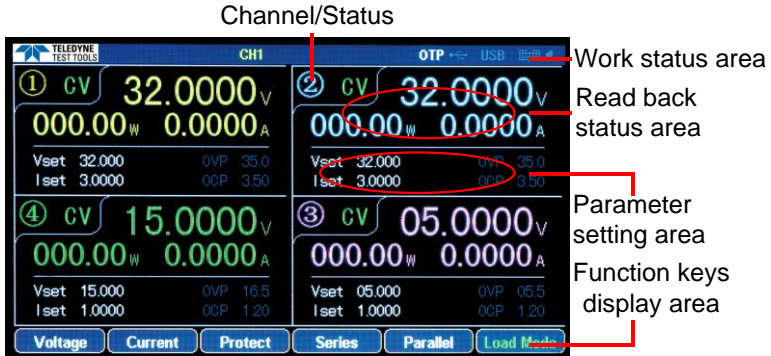



Note

1. Under the Source interface:
Each channel has its own setting area (V/I/OVP/OCP) and read back status area (V/I/W).
2. Under the Load interface:
It is basically equivalent to Source interface with additional Load and OPP status displays.

Diverse display screens

In order to offer information display of each channel to meet requirements from different users, the T3PSX3200P series provide several selections of different display screens as follows:

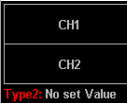
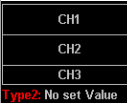
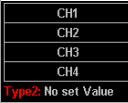
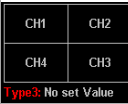
	Type	T3PS13206P	T3PS23203P	T3PS33203P	T3PS43203P
Nomarl	Type1	×	<p>CH1 setting CH2 setting Type1: With set Value</p>	<p>CH1 setting CH2 setting CH3 setting Type1: With set Value</p>	<p>CH1 setting CH2 setting CH3 setting CH4 setting Type1: With set Value</p>

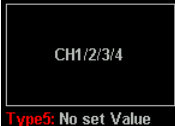
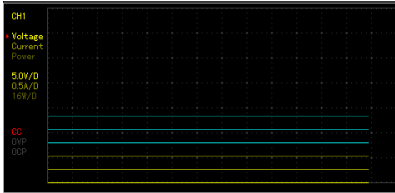
	Type2	×			
	Type3	×	×	×	
	Type4				
	Type5				
Waveform	Type6				
	Type7				

*Only Type 1, Type 4 and Type 7 have setting value display

Default factory display screen

T3PS13206P	T3PS23203P	T3PS33203P	T3PS43203P
Type4	Type1	Type1	Type1

The introduction to Type 6 display

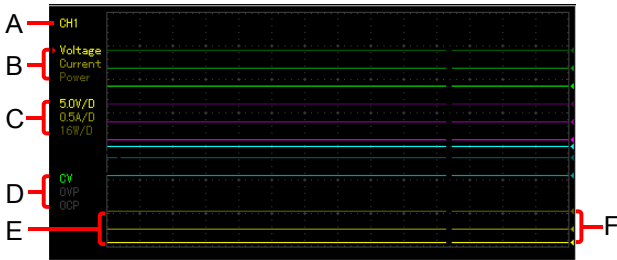

Item	Description
A	The currently edited channel, which can be toggled through the channel button on the panel.
B	The adjustable items of reference point for voltage/current/power respectively in the active channel. The one with a red triangular arrow is the active item to adjust, which can be toggled through the directional button on the panel.
C	The vertical sensitivity for voltage/current/power respectively in the active channel.
D	The output state of active channel and the open state of OVP/OCP.
E	The output curve for voltage/current/power respectively in the active channel. The three curves have the identical color in common with slight difference in brightness, which corresponds to the brightness of B.
F	The output reference point for voltage/current/power respectively in the active channel, which is adjustable ups and downs via scroll wheel.

Source Function



Description Each channel is equipped with basic power functions and able to display both settings and read back value of V/I as well as output status

Parameter description	Vset	Set output voltage of active channel. The range is as the following: CH1: 0.000V-33.000V CH2: 0.000V-33.000V CH3: 0.000V-5.500V (T3PS43203P) CH4: 0.000V-16.000V (T3PS43203P)
	Iset	Set limited current of active channel. The range is as the following: CH1: 0.0000A-3.2000A CH2: 0.0000A-3.2000A CH3: 0.0000A-1.1000A (T3PS43203P) CH4: 0.0000A-1.1000A (T3PS43203P)
	OVP	Set OVP. The range is as the following: CH1: 0.5V-35.0V CH2: 0.5V-35.0V CH3: 0.5V-6.0V (T3PS43203P) CH4: 0.5V-16.5V(T3PS43203P)
	OCP	Set OCP. The range is as the

following:

CH1: 0.05A - 3.30A

CH2: 0.05A - 3.30A

CH3: 0.05A - 1.20A (T3PS43203P)

CH4: 0.05A - 1.20A (T3PS43203P)

Parameter Voltage
Setting (CH1 for
example)

Press the F1 key corresponding to Voltage to activate voltage setting area on LCD (red font color with the underline indicator).



(a) Input digit with number pad (0-9,.) and press unit key F1(V) or F2(mV) to confirm:

Input 6.543V:



(b) Step input:
Press the left or right arrow buttons to select high and low level that require fine-tune (underline below the corresponding number value), and scroll the scroll wheel to increase or decrease setting value.

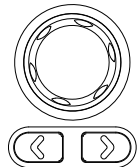

Current

Press the F2 key corresponding to Current to activate current setting area on LCD (red font color with the underline indicator).



(a) Input digit with number pad (0-9,) and press unit key F1(A) or F2(mA) to confirm:

Input 1.543V:



(b) Step input:

Press the left or right arrow buttons to select high and low level that require fine tune (underline below the corresponding number value), and scroll the scroll wheel to increase or decrease setting value.

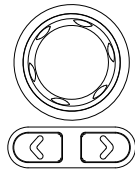

OVP

Press F3 key to enter the Protect menu.



Press F3 key to open OVP function. OVP display will change from gray to white font.



Press the F1 key to enter OVP setting area on LCD, which will be thus activated (red font color with the underline indicator).



(a) Input digit with number pad (0-9,) and press unit key F1(V) or F2(mV) to confirm:

Input 6.5V:



(b) Step input:
 Press the left or right arrow buttons to select high and low level that require fine tune (underline below the corresponding number value), and scroll the scroll wheel to increase or decrease setting value.

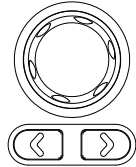

OCP

Press F3 key to enter the Protect menu.



Press F3 key to open OCP function. OCP display will change from gray to white font.



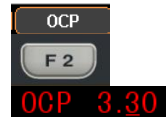

Press the F2 key to enter OCP setting area on LCD, which will be thus activated (red font color with the underline indicator).



(a) Input digit with number pad (0-9,.) and press unit key F1(A) or F2(mA) to confirm:

Input 2.5A:



	Caution	There's no proper sequence between turning on OVP/OCP functions and setting OVP/OCP value.
		Either step input or number pad input is applicable for setting parameter value.
Operation	ON/OFF	Output ON/OFF control. Output is open when output lights up; whilst output is off when output lights out.
		All ON/OFF Press All ON/OFF key to output all. All channels output are open when output lights up, and output light of each channel will light up simultaneously, whilst all channels output are off when output lights out.
State description	CV/CC	Constant voltage displays in green CV,   while constant current displays in red CC.
		OVP/OCP OVP/OCP displays in white when OVP is not in activation.
		OVP/OCP displays in red and output is off when OVP is activated.
		OVP/OCP displays in gray when OVP/OCP functions are off.

Independent Output Mode

Description	Each channel within the models T3PS13206P/23203P/33203P/43203P is separate from one another and capable of operations including independent setting and individual output, etc.
-------------	---

Connection

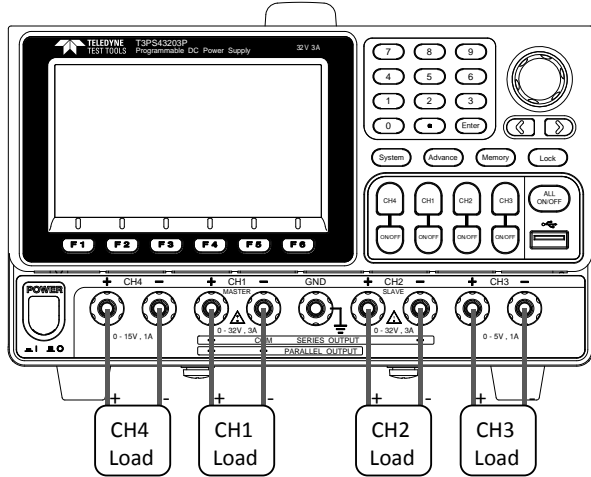

Voltage/ Current Rating T3PS13206P: 32V/6A x 1
 T3PS23203P/33203P/43203P:
 CH1/CH2: 32V/3A x 2
 CH3:1.8V/2.5V/3.3V/5V/5A x 1(T3PS33203P)
 USB Port Output: 3A (T3PS33203P)
 5V/1A x 1 (T3PS43203P)
 CH4: 15V/1A x 1

Setting 1. Press F4 or F5 button to enter the independent output mode.
 2. For setting operation of parameter, refer to page 33.

Output The independent button ON/OFF of each channel is available, while All ON/OFF button is available for all channels.

Tracking Series and Tracking Parallel Modes

Description Tracking series operation doubles the Voltage capacity of the T3PS23203P/33203P/43203P by internally connecting CH1 (Master) and CH2 (Slave) in series and combining the output to a single channel. CH1 (Master) controls the combined Voltage output level.

Tracking series without common terminal

Connection

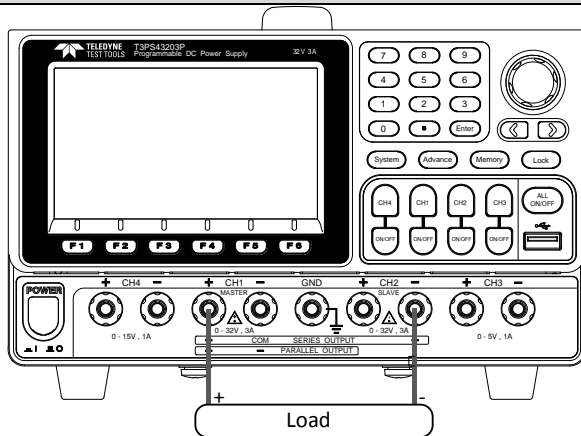

Output rating rating 0 - 64V/0 - 3A

- Setting**
1. Press F4 or F5 button for operating the corresponding Series to enter the tracking series function. Yellow SER will be shown on the status area.
 2. Press CH1 button to proceed to CH1/CH2 voltage setting and CH1 limit current setting.
 3. Press CH2 button to proceed to CH2 limit current setting.
 4. For setting operation of parameter, refer to page 33.

Output The button ON/OFF of CH1/CH2 is individually available, while All ON/OFF button is available for all channels.

Tracking series with common terminal

Connection

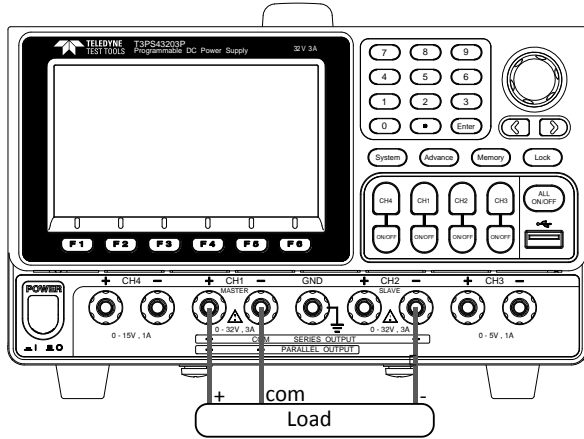

Output rating 0 - 32V/0 - 3A for CH1+ - COM
 0 - 32V/0 - 3A for CH2- - COM

- Operation**
1. Press F4 or F5 button for operating the corresponding Series to enter the tracking series function. Yellow SER will be shown on the status area.
 2. Press CH1 button to proceed to CH1/CH2 voltage setting and CH1 limit current setting.
 3. Press CH2 button to proceed to CH2 limit current setting.
 4. For setting operation of parameter, refer to page 33.

Output The button ON/OFF of CH1/CH2 is individually available, while All ON/OFF button is available for all channels.

 **Caution** Under Tracking series mode, CH1 is master, whilst CH2 is slave. Thus, output voltage setting is Not

available for CH2.

CH1/CH2 Tracking Parallel Mode

Connection

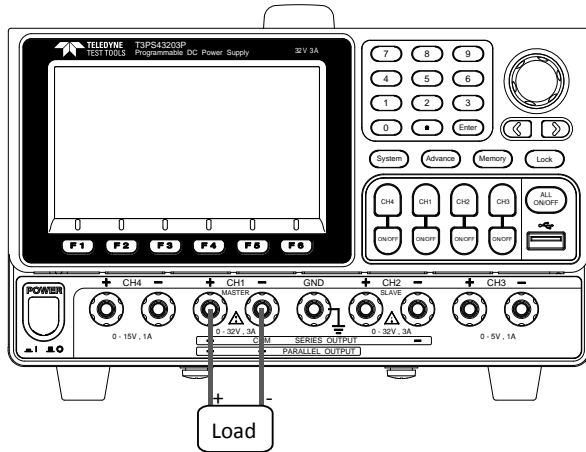

Output rating

Rating 0 - 32V/0 - 6A

Operation

1. Press F4 or F5 button for operating the corresponding Parallel mode to enter the tracking parallel function. Yellow PAR will be shown on the status area.
2. Press CH1 button to proceed to CH1/CH2 voltage/current setting.
3. For setting operation of parameter, refer to page 33.

Output

The button ON/OFF of CH1/CH2 is individually available, while All ON/OFF button is available for all channels.

 **Caution**

Under tracking parallel mode, CH1 is master, whilst CH2 is slave. Thus, output voltage/current setting is Not available for CH2.

Load Function

Description CH1/CH2 of the T3PS13206P/ 23203P/ 33203P/ 43203P can be set to the Load Mode function, under which both tracking series and tracking parallel function are Not available.



Note

The voltage ($\geq 1V$) or --- (<1V) pertaining to port appears when Output is Off.

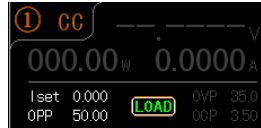

Parameter Description	Load	Under PWR. mode, press F6 (Load Mode) to enter the Load mode. LCD will display the status LOAD .
	Vset	Set rating range of voltage value under Load mode of active channel: CH1 : 1.50V-33.00V CH2 : 1.50V-33.00V
	Iset	Set rating range of current value under Load mode of active channel CH1 : 0.000A-3.200A CH2 : 0.000A-3.200A
	Rset	Set rating range of resistance value under Load mode of active channel CH1 : 1Ω-1000 Ω

CH2 : 1 Ω -1000 Ω

Others OPP : fixed 50W, not adjustable
 OVP/OCP : indential to Source

Parameter setting	Vset	Press F4 or F5 button for operating the corresponding (CV) mode followed by F1 button (Vset). The voltage setting area on LCD will be activated and appears Vset 00.00 (red font color with the underline indicator).
-------------------	------	--

(a) number pad (0-9,.) input; press unit button F1 (V) or F2 (mV) button to confirm:

Input 6.54V:



(b) Step input: Press the left or right arrow buttons to select high and low level that require fine tune (underline below the corresponding number value), and scroll the scroll wheel to increase or decrease setting value.

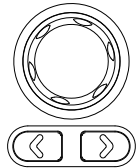

Iset	Press F4 or F5 button for operating the corresponding (CC) mode followed by F1 button (Iset). The current setting area on LCD will be activated and appears Iset 1.000 (red font color with the underline indicator).
------	--

(a) number pad (0-9,.) input; press unit button F1 (A) or F2 (mA) button to confirm:

Input 1.543A:



(b) Step input: Press the left or right arrow buttons to select high and low level that require fine tune (underline below the corresponding number value), and scroll the scroll wheel to increase or decrease setting value.

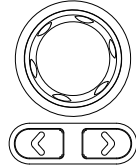

Rset Press F4 or F5 button for operating the corresponding (CR) mode followed by F1 button (Rset). The current setting area on LCD will be activated and appears **Rset 0000** (red font color with the underline indicator).

(a) number pad (0-9,.) input; press unit button F1 (OHM) to confirm:

Input 52Ω:



(b) Step input: Press the left or right arrow buttons to select high and low level that require fine tune (underline below the corresponding number value), and scroll the scroll wheel to increase or decrease setting value.

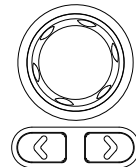

OVP The setting method is identical to
 OCP Source.

Operation	ON/OFF	Press ON/OFF to output. Output is open when output lights up; whilst output is off when output lights out.
	All ON/OFF	Press All ON/OFF key to output all. All channels output are open when output lights up, and output light of each channel will light up simultaneously, whilst all channels output are off when output lights out.
Mode	CV CC CR	Font color appears in orange under Load mode. 

Sequence Function

Description This function can be used for practical applications when different voltage waveforms are required to be output. Users can edit the output waveform according to their needs. The amplitude range of the output waveform is the output voltage range of power supply. The setting range for output waveform duration is 1s (duration calculation: Time x Groups x Cycles) and the resolution is 1s.



Caution

This feature is applicable to both CH1 and CH2.

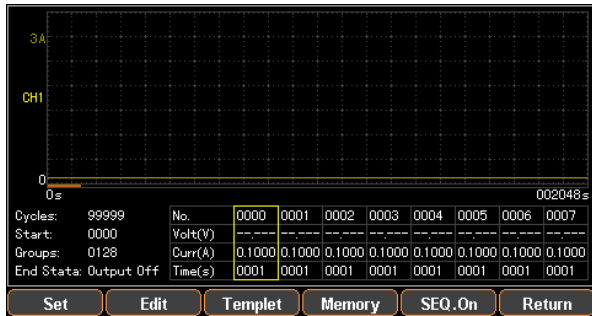

Set Sequence Output

Parameter Description

Cycles Cycle number, 1 represents a cycle of single period, whilst 2 indicate a cycle with 2 periods, and so on. The range is from 0 to 9999 or Infinite.

Start The number to execute, 0 indicates the execution starts from the group 0, while 1 indicates it begins from the group 1, and so on. The range is from 0 to 2047.

Groups The number to be executed. It can NOT exceed 2048 for Start+Groups.

	End Status	There are 2 statuses after the necessary Group and Cycle are executed: output termination or being hold with the last step.
Parameter Setting	Cycles	Press the Advance key on control panel. Select F2 (Sequence) function. Press F1 (Set) button followed by selecting F1 (Cycles). The setting on LCD is activated and appears in red font color Cycles: 99993 . Use number pad to set the parameters directly and then press the F1 (Done) button to confirm; or use arrow keys along with scroll wheel to complete the setting. Press and hold the F5 (Infinite) button if Infinite execution is in need.
	Start	Under the Sequence function, press F1 (Set) button followed by selecting F2 (Start). The setting on LCD is activated and appears in red font color Start: 2047 . Use number pad to set the parameters directly and then press the F1 (Done) button to confirm; or use arrow keys along with scroll wheel to complete the setting.
	Groups	Under the Sequence function, press F1 (Set) button followed by selecting F3 (Groups). The setting on LCD is activated and appears in red font color Groups: 0001 . Use number pad to set the parameters directly and then press the F1 (Done) button to confirm; or use arrow keys along with scroll wheel to complete the setting.
	End State	Under the Sequence function, press F1 (Set) button followed by selecting F4

(End State), and 2 statuses Last/Output off will appear in turn on LCD

End State: Last. The one displaying is what's called the current status.

Operation	ON/OFF	Press the F5 (SEQ.On) button. When the output is on, the Output key will light up. When the output is off, the Output key will not be lit. SEQ will appear in the status area (yellow for CH1 only, blue for CH2 only, while white for both on).
-----------	--------	--



Caution

If the channel has been in Output ON before Sequence function, the status remains unchanged until SEQ.On so that Sequence starts to output.



Set Group Parameter

Description	Each Group consists of Voltage, Current and Time. Therefore, properly confirm parameter of each group is correct before setting Sequence output.
-------------	--

Parameter Description	No.	Group number. Maximum 2047
	Voltage	Voltage setting of each group.
	Current	Range: 0-33V
	Time	Current setting of each group. Range: 0-3.2A Execution duration of each group. Range: 1S - 300S

Parameter Setting	No.	Under the Sequence function, press F2 (Edit) button followed by selecting F1 (No.). The setting on LCD is activated and appears in red font color No. 0000 . Use number pad to set the parameters directly and then press the F1 (Done) button to confirm; or use
-------------------	-----	--

arrow keys along with scroll wheel to complete the setting.

- Voltage** Under the Sequence function, press F2 (Edit) button followed by selecting F3 (Voltage). The setting on LCD is activated and appears in red font color . Use number pad to set the parameters directly and then press the F1 (V) or F2 (mV) button to confirm; or use arrow keys along with scroll wheel to complete the setting.
- Current** Under the Sequence function, press F2 (Edit) button followed by selecting F4 (Current). The setting on LCD is activated and appears in red font color . Use number pad to set the parameters directly and then press the F1 (A) or F2 (mA) button to confirm; or use arrow keys along with scroll wheel to complete the setting.
- Time** Under the Sequence function, press F2 (Edit) button followed by selecting F2 (Time). The setting on LCD is activated and appears in red font color . Use number pad to set the parameters directly and then press the F1 (Second) button to confirm; or use arrow keys along with scroll wheel to complete the setting.

Construct Template

Description	<p>This function can be used for practical applications when different voltage waveforms are required to be output. Users can edit the output waveform according to their needs. The built-in Sine, Pulse, Ramp, Stair Up, Stair Dn, Stair UpDn, Exp Rise, Exp Fall waveforms are available to use.</p>	
Parameter Description	Object	To edit Voltage or Current
	Type	Select the built-in waveforms including Sine, Pulse, Ramp, Stair Up, Stair Dn, Stair UpDn, Exp Rise, Exp Fall.
	Max Value	Set the max. value of waveform voltage/current
	Min Value	Set the min. value of waveform voltage/current
	Start	Set the initial group number of waveform. Maximum: 2037
	Points	Select the required points. Range: 10-2047
	Inverted	Invert the selected waveform
Parameter Setting	Object	<p>Press the F1 (Object) button to select Voltage Object Voltage / Current Object Current in turn. Simply stop at the parameter which is in need of setting.</p>
	Type	<p>After pressing the F2 (Type) button, select the button corresponding to the applicable waveform. Up to 8 default waveforms are available for selection.</p>

- Max Value** Press the F3 (Max Value) button. The setting on LCD will be activated and appears in red font color **Max Value 33.000V**. Use number pad to set the parameters directly and then press the F1 (V/A) or the F2 (mV/mA) button to confirm; or use arrow keys along with scroll wheel to complete the setting.
- Min Value** Press the F4 (Min Value) button. The setting on LCD will be activated and appears in red front color. Use number pad to set the parameters directly and then press the F1 (V/A) or the F2 (mV/mA) button to confirm; or use arrow keys along with scroll wheel to complete the setting.
- Start** Press the F5 (More) button and then press the F1 (Start) button. The setting on LCD will be activated and appears in red font color **Start 1920**. Use number pad to set the parameters directly and then press the F1 (Done) to confirm; or use arrow keys along with scroll wheel to complete the setting.
- Points** Press the F2 (Points) button. The setting on LCD will be activated and appears in red font color **Points 0123**. Use number pad to set the parameters directly and then press the F1 (Done) to confirm; or use arrow keys along with scroll wheel to complete the setting.

- Interval Press the F3 (Interval) button. The setting on LCD will be activated and appears in red font color **Interval 009**. Use number pad to set the parameters directly and then press the F1 (Done) to confirm; or use arrow keys along with scroll wheel to complete the setting.
- Inverted Press the F4 (Inverted) button. On (inverted) **Inverted On** and Off (non-inverted) **Inverted Off** appear on LCD in turn. Simply stop at the status which is required.

Construct Construct Press the F5 (Construct) to complete construction.

Menu Tree

Description User is able to understand the overall functions of Sequence via the menu tree, which is shown in proper order by tiers. The Return key is used for moving back to the parent menu. See the construction below:

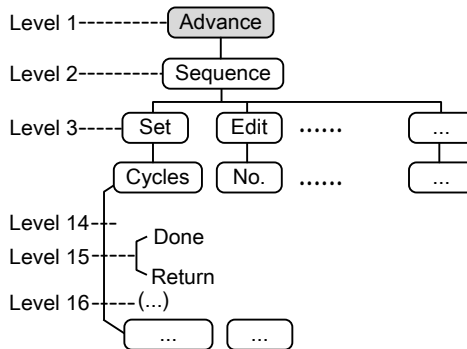

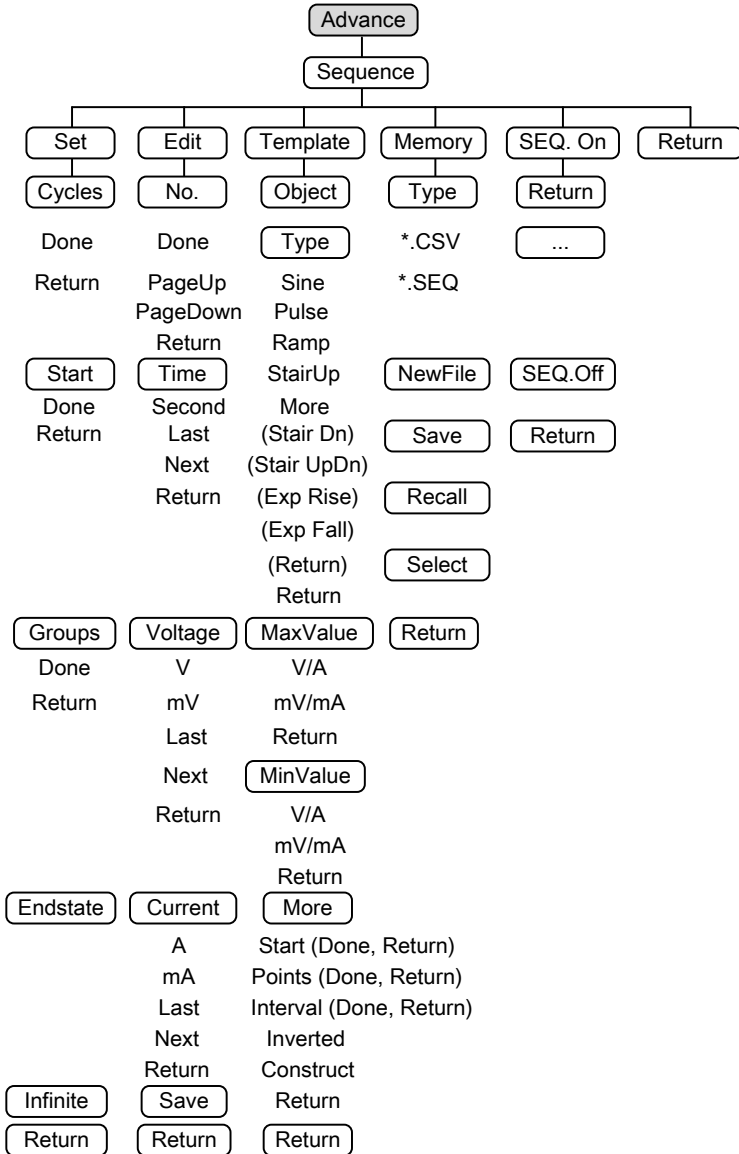

Note

In the Memory menu, Type/*.CSV/*.SEQ/New File/Select appear only when flash drive is plugged in.

Save and Recall

Description T3PSX3200P series models can save and recall the Sequence data from 10 internal groups or flash drive.

Parameter Description	Type	Available for *.CSV or *.SEQ file type
	New File	Available for creating new *.CSV or *.SEQ file type *.CSV or *.SEQ file type
	Save	Save the Sequence data to the specified file.
	Recall	Recall the data saved in the specified file.
	Select	Select the file folder in need.

Operation **Internal storage** 1. In the Sequence menu, press F4 (Memory) button to enter the page as figure show below.

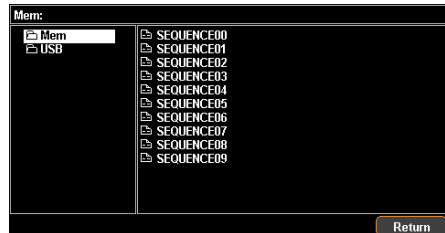

2. Press right arrow button to enter the list of 10 groups.

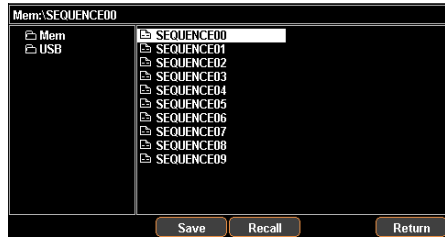

3. Rotate the scroll wheel (Encode) to select target file.
4. Press F3 (Save) button to save the settings of Sequence into the corresponding file.
5. Press the F4 (Recall) button to recall the Sequence file of list to the current sequence settings when necessary.

Flash drive storage

1. Plug flash drive in before rotating the scroll wheel (Encode) to select flash drive.
2. Press right arrow button to enter the root directory of flash drive.
3. Press F1 (Type) button to select required file type *.CSV or *.SEQ.
4. Rotate the scroll wheel (Encode) to select target file.



5. Press F3 (Save) button to save the settings of Sequence into the corresponding file.
6. Press the F4 (Recall) button to recall the Sequence file of list to the current sequence settings when necessary.

Delay Function

Description It is necessary to output a series of pulses in real applications. This function is available when voltage is constant. Output waveform can be edited per user's preference. The amplitude range of the output waveform is the output voltage range of the power supply. The setting range for output waveform duration is 1s ~ Infinite (duration calculation: Time x Groups x Cycles) and the resolution is 1s.



Note

This feature is applicable to both CH1 & CH2.

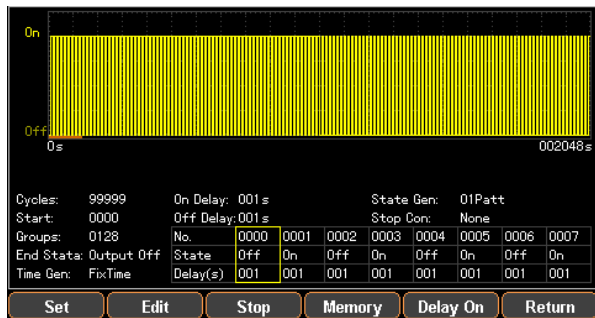

Set Delay Output

Parameter Description

Cycles Cycle number, 1 represents a cycle of single period. 2 represents a cycle with 2 periods, and so on. The range is from 0 to 9999 or Infinite.

Start The number (No.) to start execute. 0 indicates the execution starts from the group 0, while 1 indicates it begins from the group 1, and so on. The range is from 0 to 2047.

Groups	The number to be executed. It can NOT exceed 2048 for Start+Groups.
End State	There are 2 statuses after the necessary Group and Cycle are executed: output termination or being hold with the last step.
Stop Condition	Halt the current operation based on the set condition of Voltage/Current/Power.

Parameter Setting	Cycles	Press the Advance key on control panel. Select the F3 (Delay) function. Press the F1 (Set) button followed by selecting F1 (Cycles). The setting on LCD is activated and appears in red font color Cycles: 99993 . Use number pad to set the parameters directly and then press the F1 (Done) button to confirm; or use arrow keys along with scroll wheel to complete the setting. Press and hold the F5 (Infinite) button if Infinite execution is in need.
	Start	Under the Delay function, press the F1 (Set) button followed by selecting the F2 (Start). The setting on LCD is activated and appears in red font color Start: 2047 . Use number pad to set the parameters directly and then press the F1 (Done) button to confirm; or use arrow keys along with scroll wheel to complete the setting.
	Groups	Under the Delay function, press the F1 (Set) button followed by selecting the F3 (Groups), the setting on LDC will be activated and appears in red font Groups: 0001 . Use number pad for direct

setting followed by pressing F1 (Done) key to confirm; or use arrow keys along with scroll wheel to complete setting.

End State Under the Delay function, press the F1 (Set) button followed by selecting the F3 (Groups), and 2 statuses Last/Output off will appear in turn on LCD **End State: Last**. The one displaying is what's called the current status.

Stop Condition Under the Delay function, press the F3 (Stop) button and halt the operation by setting voltage F2 (Voltage), current F3 (Current) and power F4 (Power), or Stop infinitely by F1 (None).

Operation **ON/OFF** Press the F5 (Delay On) button. Output is open when output lights up; whilst output is off when output lights out. DLY appears on the status bar (yellow for CH1, blue for CH2, and white for both CH1 & CH2 on).



Warning

If the channel has been in Output ON before Delay function, the status remains unchanged until Delay.On so that the corresponding waveform starts to output.

Set Group Parameter

Description Each Group consists of Voltage, Current and Time. Therefore, properly confirm parameter of each group is correct before setting Delay output.

Parameter Description	No.	Group number. Maximum 2047
	State	Output status of each group: On, Off
	Time	Execution duration of each group.

		Range: 1s - 300s
	Pattern	Set the initial status of initial group. 01 Patt: start from Off; 10Patt: start from On
	Time set	It is used to generally set the pattern of time change. Model is for the changes covering fix (FixTime), increase (Increase) and decline (Decline). Base Time is for setting time of initial Group. Step is for setting time interval of neighboring Group.
Parameter Setting	No.	Under the Delay function, press the F2 (Edit) button followed by selecting the F1 (No.). The setting on LCD is activated and appears in red font color  . Use number pad to set the parameters directly and then press the F1 (Done) button to confirm; or use arrow keys along with scroll wheel to complete the setting.
	State	Under the Delay function, press the F2 (Edit) button, and then the F2 (State) button followed by selecting F1 (On), F2 (Off) or F3 (Inverted) to set output On/Off status of each group.
	Time	Under the Delay function, press the F2 (Edit) button followed by selecting the F3 (Time). The setting on LCD is activated. Use number pad to set the parameters directly and then press the F1 (Second) button to confirm; or use arrow keys along with scroll wheel to complete the setting.
	Pattern	Under the Delay function, press the F2 (Edit) button followed by selecting F4 (Pattern), and then set up via F1

(01Patt) and F2 (10Patt). The live setting result appears on the LCD.

Time Set Under the Delay function, press the F2 (Edit) button followed by selecting the F5 (Time Set), and then set time change patterns of each group, 3 types (fix (FixTime), increase (Increase) and decline (Decline) of which are available) via F1 (Model). The live setting result appears on the LCD.

On Delay When fix (FixTime) is set in Time Set,
Off Delay it's available to set the time value of both F2 (On Delay) and F3 (Off Delay) at the same time.

Base When increase (Increase) or decline
Time Step (Decline) is set in Time Set, it's available to set the time value of F2 (Base Time) start time and F3 (Step) group change at the same time.

Menu Tree

Description User is able to well understand the overall functions of Delay via menu tree, which is put in proper order by tiers. The Return key is used for back to the parent menu. See the construction below:

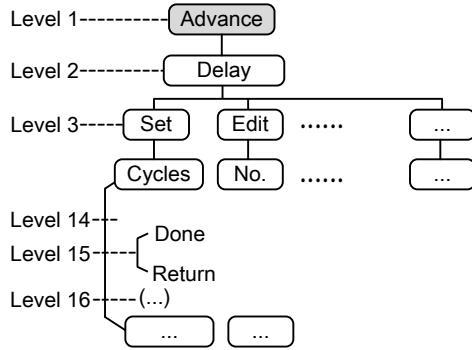

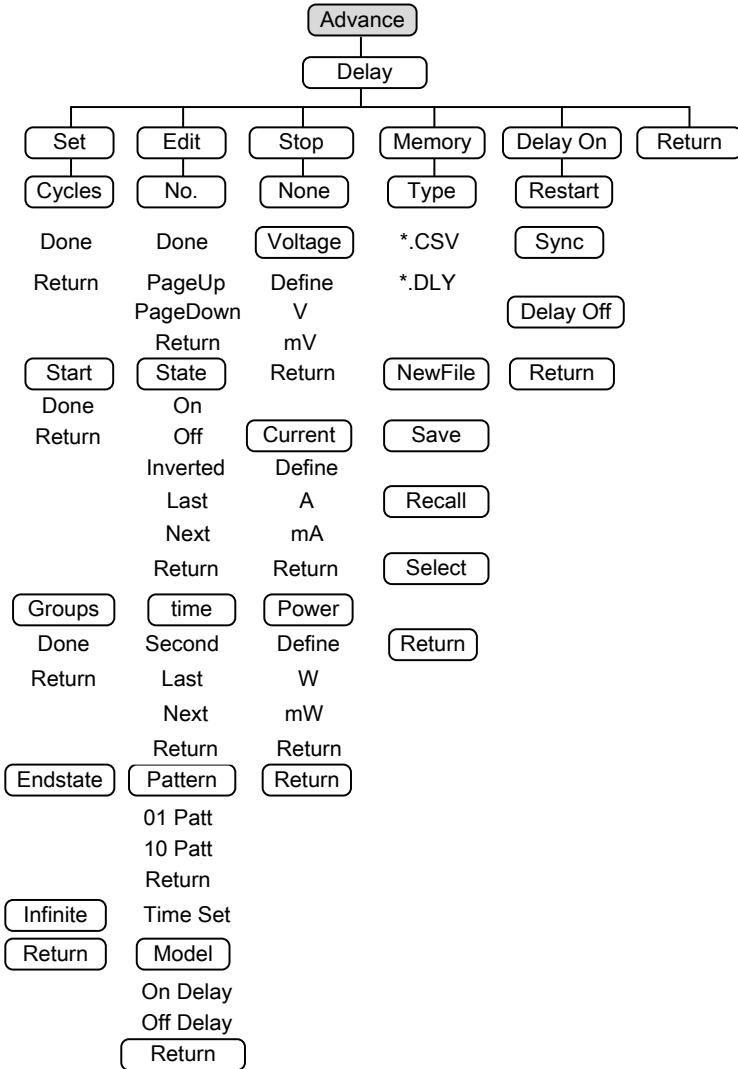

Note

In the Memory menu, Type/* .CSV/* .DLY/New File/Select appear only when flash drive is plugged in.

Save and Recall

Description	T3PSX3200P series models can save and recall the Delay data from internal 10 groups or flash drive.	
Parameter Description	Type	Available for *.CSV or *.DLY file type
	New File	Available for creating new *.CSV or *.DLY file type
	Save	Save the Delay data to the specified file.
	Recall	Recall the data saved in the specified file.
	Select	Select the file folder in need.

- Operation
- Internal storage
1. In the Delay menu, press F4 (Memory) button to enter the page as figure show below.

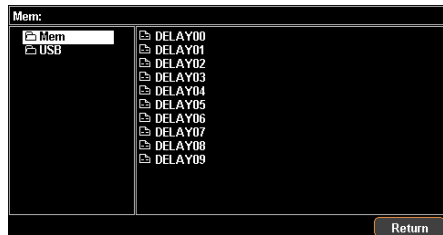

2. Press right arrow button to enter the list of 10 groups.



3. Rotate the scroll wheel (Encode) to

select target file.

4. Press F3 (Save) button to save the settings of Sequence into the corresponding file.
5. Press the F4 (Recall) button to recall the Sequence file of list to the current sequence settings when necessary.

Flash drive storage

1. Plug flash drive in before rotating the scroll wheel (Encode) to select flash drive.
2. Press right arrow button to enter the root directory of flash drive.
3. Press F1 (Type) button to select required file type *.CSV or *.DLY.
4. Rotate the scroll wheel (Encode) to select target file.



5. Press F3 (Save) button to save the settings of Delay into the corresponding file.
6. Press the F4 (Recall) button to recall the Delay file of list to the current sequence settings when necessary.

Monitor Function

Description In order to have well understanding of the channel under long-term output, the T3PSX3200P series has the additional live monitor function, which helps guarantee load status of client via halting operation based on certain preset conditions.



Note

This feature is Not applicable to CH3 of T3PS33203P.



Set Monitor

Parameter Description	Voltage Set condition of monitor of voltage.
	Current Set condition of monitor of current.
	Power Set condition of monitor of power.
	Stop Type Set status after halt. 3 types are available, output disable, content notice and audible alarm.
	Select To confirm if voltage/current/power is selected as monitor object. White font stands for selected, while gray font represents not selected.

Parameter Setting	Voltage	<ol style="list-style-type: none">1. Press the Advance key on control panel. Select the F4 (Monitor) function followed by pressing the F1 (Voltage) button to enter the voltage setting.2. Press the F1 (Set) button. The setting on LCD is activated and appears in red font color. Use number pad to set the parameters directly; or use arrow keys along with scroll wheel to complete the setting.3. Press the F4 (Define) button to define terminated condition.4. Press the F5 (Logic) button to define logical pattern of other conditions.
	Current	<ol style="list-style-type: none">1. Press the Advance key on control panel. Select the F4 (Monitor) function followed by pressing the F2 (Current) button to enter the current setting.2. Press the F1 (Set) button. The setting on LCD is activated and appears in red font color. Use number pad to set the parameters directly; or use arrow keys along with scroll wheel to complete the setting.3. Press the F4 (Define) button to define terminated condition.4. Press the F5 (Logic) button to define logical pattern of other conditions.
	Power	<ol style="list-style-type: none">1. Press the Advance key on control panel. Select the F4 (Monitor) function followed by pressing the F3 (Power) button to enter the power setting.

2. Press the F1 (Set) button. The setting on LCD is activated and appears in red font color. Use number pad to set the parameters directly; or use arrow keys along with scroll wheel to complete the setting.
3. Press the F4 (Define) button to define terminated condition.
4. Press the F5 (Logic) button to define logical pattern of other conditions.

Stop Type Press the Advance key on control panel. Select the F4 (Monitor) function followed by pressing the F4 (Outoff) button to set output disable; select F2 (Alarm) to set content notice; select F3 (Beeper) to set audible alarm.

Operation ON/OFF Press the F5 (MON. On) button to enter live monitor. MON appears on the status bar (the color of channel remains the original when single channel is enabled, whilst it turns to white when multiple channels are activated).

Recorder Function

Description In order to understand the channel under long-term output, the T3PSX3200P series has the additional live record function, which saves file via media for further analysis later.



Note

This feature is Not applicable to CH3 of T3PS33203P.

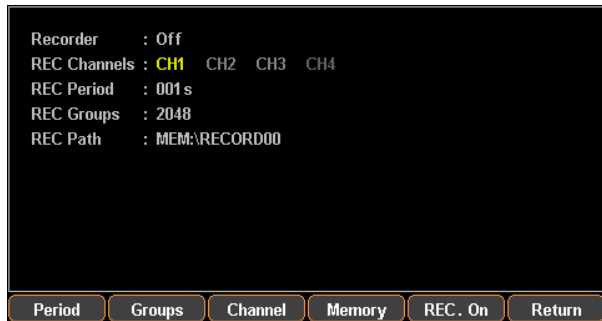

Set Recorder

Parameter Description	Period	Set period of each recorded.
	Groups	Set recorded group number.
	Channel	Set recorded channel.
	Memory	Set saving location of record.
Parameter Setting	Period	Press the Advance key on control panel. Select F5 (Recorder) function. Press F1 (Period) button to enter setting of recorded period. The setting on LCD is activated and appears in red font color. Use number pad to set the parameters directly and then press the F1 (s) button to confirm; or use arrow keys along with scroll wheel to complete the setting.

- Groups** Press the Advance key on control panel. Select the F5 (Recorder) function. Press the F2 (Groups) button to enter setting of recorded group number. The setting on LCD is activated and appears in red font color. Use number pad to set the parameters directly and then press the F1 (Done) button to confirm; or use arrow keys along with scroll wheel to complete the setting.
- Channel** Press the Advance key on control panel. Select the F5 (Recorder) function. Press the F3 (Channel) button to enter setting of recorded channel. F1 (CH1), F2 (CH2), F3 (CH3), F4 (CH4) are available for selection. The numbers of channel may vary by models.
- Memory** Press the Advance key on control panel. Select the F5 (Recorder) function followed by pressing F4 (Memory) button to setting of recorded saving.



- Internal Storage**
1. Press right arrow button to enter the list of 10 groups. Rotate the scroll wheel (Encode) to select target file. Also rotate the scroll wheel (Encode) to enter the flash

drive when necessary.



2. Press F3 (Save) button to save the temporary data into the corresponding file.
3. Press F4 (Recall) button to save the record data of file into the temporary storage for further saving into flash drive later.

Flash drive Type/*.*CSV/ *.REC/New File/Select operation buttons appear when flash drive is description selected.

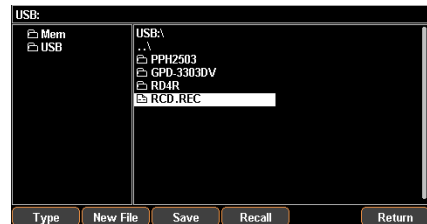

- Type is used to select *.CSV and *.REC file types.
- New File is used to create new file.
- Select is used to open the required file folder.

Operation ON/OFF Press F5 (REC.On) button to enter live record function. REC appears on the status bar (the color of channel

remains the original when single channel is enabled, whilst it turns to white when multiple channels are activated).

External I/O Control

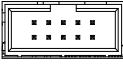
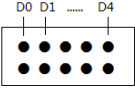
Description	The T3PSX3200P series models provides user with a programmable external trigger port.	 <p>Control I/O</p>
Function	<p>It can turn each Data Line (D0,D1,D2,D3,D4) into input signal respectively to have command of the following four functions:</p> <ol style="list-style-type: none"> 1. Control of channel On/Off 2. Control of Tracking mode 3. Toggle between PWR/Load modes 4. Toggle between CC/CV/CR modes under Load <p>The conditions listed below for output signal setting:</p> <ol style="list-style-type: none"> 1. Channel output On/Off 2. Beyond the setting of Voltage/Current/Power 	
Rear Pannel Control Port	Up to 10 terminals within the control port; the upper 5 terminals can be set input/output functions, while the lower 5 are ground terminals. See diagram in right side for details (rear view).	

Schematic diagram for control signal

The control circuit of each port is illustrated as the diagram below (D1 for example)

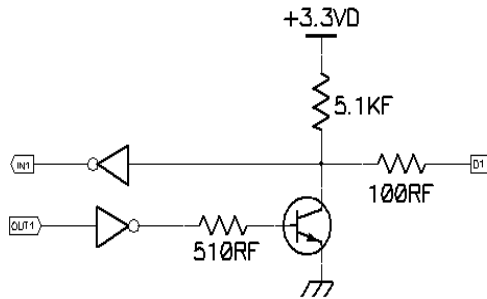

Key Function Description

Input/Output Mode:

Key	Function	Operation Result
F1	Data Line	Select object to be set from D0 to D4
F2	Enable	Set to Enable or Disable function of the port
F3	Mode	Set which mode to adopt: Input Mode or Output Mode
F4	Channel	Select corresponding channel: F1(CH1), F2 (CH2), F3 (CH3), F4 (CH4)
F5	More	
F6	Return	

F5 (More) under Input Mode setting:

Key	Function	Operation Result
F1	Type	Select trigger type: F1(RiseEdge), F2 (FallEdge), F3 (Hi-Level), F4 (Lo-Level), , F5(States Input)
F2	Response	Set result after trigger response: F1(Output) sets as ON, OFF or reverse Toggle F2 (PWR.Mode) sets channel as power mode F3 (Load Mode) set channel as load CV/CC/CR mode

F4(Track Mode) sets tracking mode of CH1/CH2	
F3	Sensitivity Set sensitivity of trigger: High/Middle/Low
F4	
F5	
F6	Return

F5 (More) under Output Mode setting:

Key	Function	Operation Result
F1	Condition	Set response type: F1(Output), F2 (Voltage), F3 (Current), F4 (Power), F5 (Auto)
F2	Polarity	Set the polarity of output signal
F3		
F4		
F5	State Out.	Enable or disable the state output
F6	Return	

Description	
-------------	--

Operation	<p>Press the System key on control panel. Select the F1 (Interface) function followed by pressing the F5 (Control I/O) button to enter the setting of external I/O.</p> <p>Press the F1 (Data Line) button. Select required data line from D0 through D5: F1(D0), F2(D1) , F3(D2) , F4(D3) , F5(D4).</p> <p>Press the F2 (Enable) button to set this terminal as input or output function. This button enables Trigger in or Trigger out to be selected in turn.</p> <p>Press the F3 (Mode) button to set this terminal as input or output function. This button enables Input Mode or Output Mode to be selected in turn.</p> <p>Press the F4 (Channel) button to activate the</p>
-----------	---

function of this terminal. This button enables Enable or Disenable to be selected in turn.

Key F5 (More) After pressing the F3 (Mode) button, Trigger in and Trigger out will bring about different results individually. Refer to the table above for details.

FILE OPERATION

Save/Recall	77
Restore Factory Default Settings	80
Default setting of each channel	80
Default setting of system	80

Save/Recall

Description System provides user with 4 different files, each of which has 10 groups including parameter setting *.set, use record *.rec, sequence output *.seq and delay output *.dly.



Note

Both file folder and name in flash drive are limited within 10 characters.

- Set file operation *.set**
1. Press the Memory button to enter the interface. Rotate the scroll wheel (Encode) to select file of either internal memory or flash drive.



2. Press the right arrow button to enter the file group. Rotate the scroll wheel (Encode) and stop at the file in need



3. Press the F3 (Save) button to have the settings of current model saved into the corresponding file.
4. Or press the F4 (Recall) button to recall the corresponding file, whose file name will be shown on the status bar.

Recorded file operation *.rec	Refer to page 54 for chapter of save and recall Sequence data.
-------------------------------	--



Note

.SEQ file can be edited in PC by the specified format (.CSV or *.SEQ) and imported, via flash drive, into machine.

Recorded file operation *.DLY	Refer to page 64 for chapter of save and recall Delay data.
-------------------------------	---



Note

.DLY file can be edited in PC by the specified format (.CSV or *.DLY) and imported, via flash drive, into machine.

Recorded file operation *.REC	Refer to page 77 for chapter of Memory operation of Record.
-------------------------------	---



Note

.REC file can be edited in PC by the specified format (.CSV or *.REC) and imported, via flash drive, into PC.

Power-on setting In the System Setting menu, the interface parameter settings area shows Power On. There are 2 settings to choose from, Last (the last shut down status) and Default (non-modifiable factory default setting).

To enter the function, press the System button to enter the interface followed by pressing the F2 (Power on) button.



Restore Factory Default Settings

Description There's a group of Default value, the non-modifiable factory default setting. User is able to restore Default or proceed to Preset operation from Power On under System.

Operation Press the System button to enter the interface followed by pressing either the F2 (Power On) or the F4 (Preset) button to select Default.

Default setting of each channel

Channel item	Parameter	Channel item	Parameter
Voltage	00.000V	Current	0.0000A
OVP	35V(Off)	OCP	3.5A(Off)
Disp Type	Type1(T3PS13206P :Type4)	Vset(Load)	1.500V
Model	PWR	Iset (Load)	0.000A
Tracking	Indep.	Rset(Load)	0050Ω

Default setting of system

System item	Parameter	System item	Parameter
Interface	USB	MAC Address	Factory setting
UBS Baud	115200	Subnet Mask	255.255.255.0
RS232 Baud	115200	IP Address	169.254.129.17
Beep	On	IP Mode	DHCP
Backlight	High	HOST Name	T3PSX3200P series
Power On	Default		

SYSTEM SETTINGS

System Information	82
System Settings	83
Firmware Upgrading	85
Description of Using Flash Drive	86

System Information

System Information

The picture below shows complete system information.

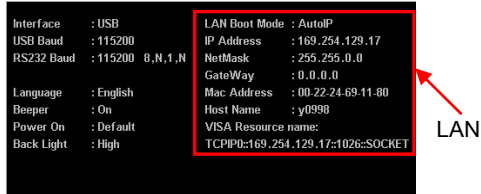

Check operation

Press the System button on the panel to show the screen as above.

System Version

Model

View the system software version.

Firmware

Software version

Serial number

View the machine serial number.

Check operation

Press the System button followed by pressing the F4 (Version) button to show the above system version window.

System Settings

Description	It can be used to perform system operations.	
Setting information	Interface	Remote control and relevant data output setting
	Power On	Power on initial state setting
	Language	menu language setting
	BackLight	Adjust the LCD brightness.
	Beep	Sets when the buzzer is turn on.
	Upgrade	Firmware upgrade
	Hardcopy	For Screenshot operation
	Preset	Restore to Factory Settings
Remote control setting	The System menu, press the F1 (Interface) button to select port. For more details, refer to page 88.	
Power on initial state setting	In the System menu, press the F2 (Power On) button to select required power on setting: Last (the last shut down setting) and Default (factory default setting).	
Menu language setting	The System menu, press the F3 (Setting) button followed by selecting the F1 (Language) to locate the F1 (English) button or the F2 (Chinese) button.	
Backlight brightness adjustment	In the System menu, press the F3 (Setting) button followed by selecting the F2 (Backlight) to adjust backlight brightness. There are three brightness levels: High, Middle, and Low. Select from pressing the F1 (Low) or F2 (Middle) or F3 (High) button.	
Buzzer operation	In the System menu, press the F3 (Setting) button followed by selecting the F3 (Beeper) to turn on or turn off the buzzer beeper.	

Firmware upgrade	In the System menu, press the F3 (Setting) button followed by selecting the F4 (Upgrade) button to upgrade the machine to the latest software version. For more details, refer to page 85.
Screenshot operation	In the System menu, press the F3 (Setting) button followed by selecting F5 (Hardcopy) to proceed to screenshot operation. For more details, refer to page 86.
Restore to Factory Settings	In the System menu, press the F5 (Preset) button to restore to the factory default setting. For more details, refer to page 80.

Firmware Upgrading

Description The T3PSX3200P allows the firmware to be updated by end-users. Before using the T3PSX3200P, please check the Teledyne LeCroy website or ask your local distributor for the latest firmware.

Upgrade Requirement Firmware file Supplied by Teledyne LeCroy
Flash drive USB2.0/USB3.0 · FAT32 file system, 16G MAX

Operation After plugging in flash drive, the corresponding symbol appears in the status bar.

Press System button;

Press F3 (Setting) button;

Press F4 (Upgrade) button;

Rotate the scroll wheel to select corresponding file;

Press the F4 (Recall) button and start to upgrade;

The procedure is done when the message, upgrading successful, shows up.

Description of Using Flash Drive

Description	It can be used when upgrading the software upgrades, screenshot operation and importing or exporting files.
Operation	Insert flash drive into the USB Host port. Then the system identifies the flash drive and the identification appears in the status bar.
Software Update	refer to page 85 ;
Screenshot operation	In the target interface, press System button > F1 (Setting) > F5 (Hardcopy) button and rotate the scroll wheel (Encode) to locate the target interface followed by pressing Enter key to save screenshot. A confirm voice will sound when successful.



The file format of screenshot is *.BMP and is saved in the root directory of flash drive by default.

Exporting the Sequence data	The files of Sequence (*.SEQ), Recorder (*.REC), Delay (*.DLY), etc within machine can be, in addition to individual format, converted to *.CSV file format for easy check and edit in PC by user. For more details, refer to page 77.
-----------------------------	--

REMOTE CONTROL

Connection Usage	88
RS-232	88
USB	89
LAN	91
Command Syntax.....	96
SCPI Commands Overview SCPI	96
Command List.....	100
Command Details.....	107
Errors	188
Error Message.....	188
Command Errors	189

Connection Usage

This chapter describes how to set and enable port, as well as all the required preparations prior to operation.

Port type	The T3PSX3200P series has 3 standard remote control ports (RS-232, USB, LAN).
Port selection	It is allowed to control the T3PSX3200P series by one remote control method at a time. Before to use, it's required to select or confirm beforehand.
Operation	Press the System button followed by pressing the F1 (Interface) button to select the target port: F1 (RS-232), F2 (USB), F4 (LAN). The available ports Interface : USB will appear on the LCD.
State	The selected port will appear in the status bar with font color in gray, for instance USB , whilst it will change to white color after successful command operation.

RS-232

Description	The T3PSX3200P series models can be remotely controlled by RS-232 connection.
Interface	Rear panel RS-232 port 
Connection	<p>Under power-off state, connect RS-232 cable and select RS-232 port in the Interface. The message USB232 will appear gray in the status bar when connected, and turns to white color while the first command connects successfully.</p> <p>Panel control will be automatically under lock state when connection is successful.</p>

Parameter Setting Press the System button followed by pressing the F1 (Interface) button to select the target port: F1 (RS-232). The setting of baud rate will appear automatically, please then choose desired setting.

Display The parameter information of RS-232 will appear on LCD. Refer to the description below:

RS232 Baud : 115200 8,N,1,N

8 --->data bit 8bit

N --->no parity bit

1 --->stop bit 1bit

N --->no flow control bit

Function check Perform the following query:

*IDN?

The unit will return the manufacturer, model, serial number and software version.

TELEDYNE, T3PS33203P, SN: xxxxxxxx, Vx.xx

Disable Remote Control Mode

- Send a remote command Locall from the PC.
- Long-press the F6 (unlock) key on the front panel.



Note

RS-232 is Not hot-plug device. Please proceed to the connection procedure under the power-off state.

USB

Description

T3PSX3200P series can be connected via USB using the USB Communications Device (CDC) class.

Interface

Rear panel USB slave port.

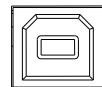

Installing the Driver Install the USB driver provided by supplier in PC.

Select USB port in the Interface after connecting the USB cable. The message USB will appear gray in the status bar when connection, and turns to white color while the first command connects successfully.

The front panel keys are automatically locked when the connection is successful.

Parameter Setting Press the System button followed by pressing the F1 (Interface) button to select the target port: F2 (USB). The setting of baud rate will appear automatically, please then choose desired setting.

Display The parameter information of USB will appear on LCD. Refer to the description below:

USB Baud : 115200

115200----> transmission baud rate

Function Check Perform the following query:

*IDN?

The unit will return the manufacturer, model, serial number and software version.

TELEDYNE, T3PS23203P, SN: xxxxxxxxx, Vx.xx

- Disabling Remote Control Mode
- Send a remote command from the PC
 - Long-press the F6 (unlock) key on the front panel.
 - Unplug the USB cable from the rear panel.
-



USB devices are hot-plug devices. You can directly remove the cable and exit.

LAN

Description	When using the LAN port, the relevant parameters are supposed to be set earlier.
-------------	--

Connection	Select LAN port in the Interface after connecting the LAN cable. The message LAN will appear gray in the status bar when connection, and turns to white color while the first command connects successfully.
------------	--

 Note	The front panel keys are automatically locked when the connection is successful.
--	--

Set port	<ol style="list-style-type: none"> 1. Press the System button to enter the system interface followed by pressing the F1 (Interface) button to configure port parameter. 2. Press the F4 (LAN) button to configure internet port parameter. 3. Press the F1 (Remote) button to disable or enable LAN. LCD will show the current setting: Enable or Disable.
----------	---

Edit Host name	<ol style="list-style-type: none"> 1. Press the System button to enter the system interface followed by pressing the F1 (Interface) button to configure port parameter. 2. Press the F4 (LAN) button to configure internet port parameter 3. Press the F2 (Config) button to configure relevant parameter.
----------------	---

4. Press the F4 (Host Name) button to manually input. The Name area will be activated and become red color after setting. The default first letter is A, and can be changed to other string by rotating scroll wheel Encoder (A, B...Z, a, b...z, 1, 2...9, 0, - in counterclockwise sequence). Press the F1 (Enter) button to confirm current string and automatically enter the next string input. Repeat the process above until completing a full name.

IP Mode	The IP address can be obtained by using either DHCP or Manual IP.
---------	---

- | | |
|-----------|---|
| Manual IP | <ol style="list-style-type: none"> 1. Press the System button to enter the system interface followed by pressing the F1 (Interface) button to configure port parameter. 2. Press the F4 (LAN) button to configure internet port parameter. 3. Press the F2 (Config) button to configure relevant parameter. 4. Press the F3 (Manual) button to manually configure. 5. Press the F1 (IP Addr) button to manually input IP address. The set content will be activated to become red color. Input required data and confirm by pressing the F1 (Done) button. Press the F5 (Clear) button to clear and input again if error occurs. 6. Return to the Manual configuration menu and repeat manually configuring NetMask. Press the F2 (NetMask) button to manually input data. The set content will be activated to become red color. Input required data and confirm by pressing the F1 (Done) button. Press the F5 (Clear) button to clear and input again if error occurs. |
|-----------|---|

7. Return to the Manual configuration menu and repeat manually configuring GateWay. Press the F3 (GateWay) button to manually input data. The set content will be activated to become red color. Input required data and confirm by pressing the F1 (Done) button. Press the F5 (Clear) button to clear and input again if error occurs.

Parameter
Settings

IP Address: IP address range: 1.0.0.0 to 223.255.255.255 (excluding 127.nnn.nnn.nnn).

Subnet Mask: Subnet Mask Range: 1.0.0.0 to 255.255.255.255.

Gateway: Gateway range: 1.0.0.0 to 223.255.255.255 (excluding 127.nnn.nnn.nnn).

VISA Resource name :
TCPIP0::169.254.129.17::1026::SOCKET

DHCP

1. Press the System button to enter the system interface followed by pressing the F1 (Interface) button to configure port parameter.
2. Press the F4 (LAN) button to configure internet port parameter.
3. Press the F2 (Config) button to configure relevant parameter.
4. Press the F1 (DHCP) button. The unit will be assigned an IP address, subnet mask, the default gateway and other network parameters from the DHCP server. The corresponding parameters will be shown in the parameter area. Use the arrow keys to view the settings.

PC Operation

1. Enter the IP address into Microsoft Internet Explorer (IE). After entering the IP address you will be shown the Welcome screen which displays the instrument information. The page also provides three links: Welcome Page, Browser Web Control and View & Modify Configuration (network settings).

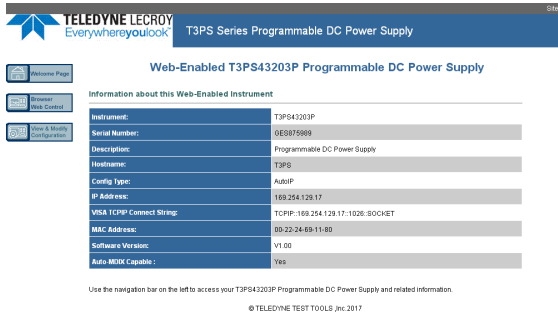

2. Click on “Browser Web Control” to execute commands through the browser, as shown below.

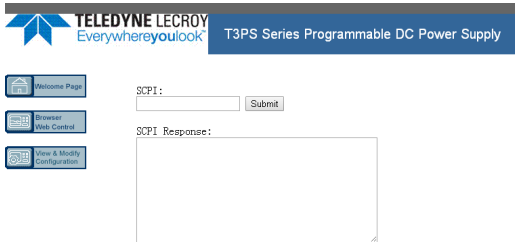

- Press the “View & Modify Configuration” icon to enter the Modify Config menu, as shown below.

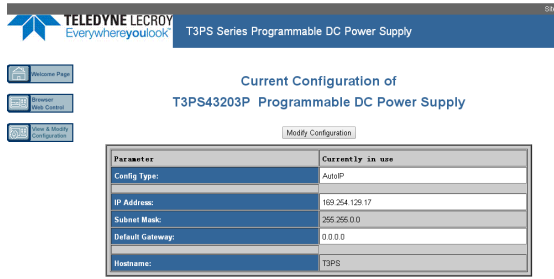

- Click “Modify Config” to enter the network configuration setting menu, as shown below. Use the mouse to click on “Save and Restart” to change the remote settings for the T3PSX3200P series.

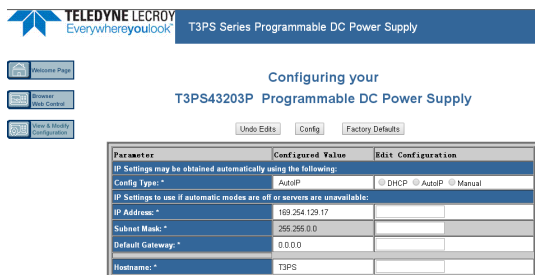

Note

Click “Undo Edits” to cancel all the edited settings. Click “Factory Defaults” to restore to the factory default settings.

Exiting from Remote Control Mode

- Send a remote command from the PC
- Long-press the F6 (unlock) key on the front panel.
- Unplug the USB cable from the rear panel.



Note

Hot-swappable LAN devices can be directly disconnected to exit.

Command Syntax

The commands that are used with the T3PSX3200P series meet IEEE488.2 and SCPI standards.

SCPI Commands Overview SCPI

Command Format SCPI is an ASCII based command language designed for test and measurement instruments. SCPI commands uses a hierarchical structure (tree system), and is divided into different subsystems. Each subsystem is defined by a different root keyword. Each command consists of a root keyword and one or more hierarchical key words separated by a colon ":" and followed by a parameter. There is always a space between the keywords and the parameters. Any commands followed by a question mark (?) are queries.

Example :SYSTem:BEEPer:STATe {0|1|OFF|ON}

:SYSTem:BEEPer:STATe?

SYSTem is the root level keyword and BEEPer and STATe are the secondary and tertiary level keywords. All levels have a ":" separating each keyword. Parameters are enclosed in "{ }".

The commands SYSTem:BEEPer:STATe has {0|1|OFF|ON} as parameters. The parameters are separated with a space.

SYSTem:BEEPer:STATe? indicates that the command is a query.

In addition some commands have multiple parameters that are usually separated by a comma ",".

Example :STATus:QUEue:ENABLE (-110:-222, -220).

Symbol Description	<p>SCPI commands have the following conventional symbols. These symbols are not commands but are used to describe the command parameters.</p> <ul style="list-style-type: none"> • Curly Brackets { } Curly Bracket enclose command string parameters, for example: {OFF ON} • Vertical Bars Vertical bars are used to separate one or more optional parameters. Only one command can be selected. With the following two parameters, {ON OFF} only ON or OFF can be selected. • Square Brackets [] The contents inside square brackets represent keywords or parameters that can be omitted when executing a command. For example: For the commands :OUTPut[:STATe] {ON OFF}, [STATe] can be omitted. • Angle Brackets < > The parameters in angle brackets must be substituted with a valid parameter. For example: For the command :DISPlay:CONTRast <brightness>, <brightness> must be use a numerical value instead such as, :DISPlay:CONTRast 1
Parameter Types	<p>The commands have a number of different parameter categories. How the parameters are set depend on the parameter categories.</p> <ul style="list-style-type: none"> • Boolean Commands parameter that have two states "OFF" and "ON", for example, DISPlay:FOCUS {ON OFF}. "ON" will turn on the focus display function, while "OFF" will turn it off. • Consecutive Integers Parameters that use consecutive integers, for example: For the command :DISPlay:CONTRast

<brightness>, <brightness> is an integer value with a range of 1~3.

- Continuous Real Number
Parameter that must be a continuous real number can have any value within the effective range and accuracy. For example: The command CURRent {<current> | MINimum | MAXimum}, is used to set the current value for the current operating channel. <current> can be any value within the setting range of the current channel.
- Discrete
For discrete parameters, only those values that are listed can be used. For example: The *RCL {0 | 1 | 2 | 3 | ... | 9} command can only use 0, 1, 2, 3, ..., 9.
- ASCII Strings
ASCII string parameters must use a combination of ASCII characters in a string. For example: For the command: MODE <name>, <name> must be an ASCII string.

Command Abbreviations

The syntax for SCPI commands contains a combination of upper and lower case letters. The upper case letters in a command represent the short form of that command.

Commands are not case sensitive and can used in both upper and lower case. Note, however, to use the short form of the command, only the capital letter part of the command can be used (no other abbreviation can be used).

Example

:MEASure:CURRent?

Can be abbreviated to :MEAS:CURR?

Command Terminators

When sending a command to the function generator, the command must be terminated with a <new line> character. The IEEE-4888 EOI can also be used as a <new line> character. A command can also be terminated using a carriage return + <new line> character. The command path will always be reset back to the root level after a command has been terminated.

Return values are terminated with 0x0A.

Command List

Measurement Commands	:MEASure[1 2 3 4] :<function>?.....	107
	VOUT<X>?	107
	IOUT<X>?	108
Display Commands	:DISPlay:ENABle 	109
	:DISPlay:ENABle?	109
	:DISPlay:BRIGhtness <NRf>	109
	:DISPlay: BRIGhtness?.....	110
	:DISPlay:TYPE {1 2 3 4 5 6 7}	110
	:DISPlay:TYPE?	110
Output Commands	:OUTPut[1 2 3 4][:STATe] 	111
	:OUTPut[1 2 3 4][:STATe]?	111
	ALLOUTON	112
	ALLOUTOFF	112
	OUT<Boolean>	112
	:OUTPut[1 2 3 4]:OVP:STATe	112
	:OUTPut[1 2 3 4]:OVP:STATe?	113
	:OUTPut[1 2 3 4]:OVP <value>.....	113
	:OUTPut[1 2 3 4]:OVP?	113
	:OUTPut[1 2 3 4]:OCP:STATe 	113
	:OUTPut[1 2 3 4]:OCP:STATe?	114
	:OUTPut[1 2 3 4]:OCP <value>.....	114
	:OUTPut[1 2 3 4]:OCP?	114
	Source and Load Commands	:SOURce[1 2 3 4]:CURRent <NRf>
ISET<X>:<NR2>.....		118
:SOURce[1 2 3 4]:CURRent?		119
ISET<X>?.....		119
:SOURce[1 2 3 4]:CURRent[:LIMit]:STATe?		119
:SOURce[1 2 3 4]:VOLTagE <NRf>		120
VSET<X>:<NR2>.....		120
:SOURce[1 2 3 4]: VOLTagE?		120
VSET<X>?		120
:SOURce[1 2]:RESistor < NRf >		121
:SOURce[1 2]:RESistor?		121
:OUTPut:SERies {ON OFF}		121
:OUTPut:PARAllel {ON OFF}		121

TRACK<NR1>	122
:LOAD[1 2]:CV{ON OFF}	122
:LOAD[1 2]:CC{ON OFF}	122
:LOAD[1 2]:CR{ON OFF}	122
:MODE[1 2]?	123
:LOAD[1 2]:RESistor <NRF>	123
:LOAD[1 2]:RESistor?	123
:DELAY[1 2]:CYCLEs {N 1},<value>	123
:DELAY[1 2]:CYCLEs?	124
:DELAY[1 2]:ENDState {ON OFF LAST}	124
:DELAY[1 2]:ENDState?	124
:DELAY[1 2]:GROUPs <NRF>	124
:DELAY[1 2]:GROUPs?	125
:DELAY[1 2]:PARAMeter <No>,{ON OFF},<time> ..	125
:DELAY[1 2]:PARAMeter? <No>,<count>]	125
:DELAy [1 2]:STARt <value>	126
:DELAy [1 2]:STARt?	126
:DELA y[1 2] [:STATe]{ON OFF}	126
:DELA y[1 2] [:STATe]?	127
:DELAy[1 2]:STATe:GENErate {01P 10P}	127
:DELAy[1 2]:STATe: GENErate?	127
:DELAy[1 2]:STOP{NONE <V >V =V <C >C =C <P	
>P =P}],<value>]	127
:DELA y[1 2]:STOP?	128
:DELA y[1 2]:TIME:GENErate	
{FIX INC DEC}],<value0>,<value1>}]	129
:DELAy[1 2]:TIME:GENErate?	130
:MONItor[1 2 3 4]:CURRent:CONDition{<C >C	
=C NONE},{AND OR NONE}	130
:MONItor[1 2 3 4]:CURRent:CONDition?	131
:MONItor[1 2 3 4]:CURRent[:VALue]{<value>	
MINimum MAXimum}	131
:MONItor[1 2 3 4]:CURRent[:VALue]?	131
:MONItor[1 2 3 4]:POWER:CONDition	
{<P >P P =P NONE}	132
:MONItor[1 2 3 4]:POWER:CONDition?	132
:MONItor[1 2 3 4]:POWER[:VALue]{<value>	
MINimum MAXimum}	132
:MONItor[1 2 3 4]:POWER[:VALue]?	133
:MONItor[1 2 3 4] [:STATe] {ON OFF}	133
:MONItor[1 2 3 4] [:STATe]?	133

:MONItor[1 2 3 4]:STOPWay{OUTOFF ALARM BEEPER},{ON OFF}	133
:MONItor[1 2 3 4]:STOPWay?	134
:MONItor[1 2 3 4]:VOLTage:CONDition{<V >V =V NONE},{AND OR NONE}	134
:MONItor[1 2 3 4]:VOLTage:CONDition?	134
:MONItor[1 2 3 4]:VOLTagef:VALue]{<value> MINimum MAXimum}	135
:MONItor[1 2 3 4]:VOLTagef:VALue}?	135
:RECOOrder[1 2 3 4]:PATH?	135
:RECOOrder[1 2 3 4]:MEMory{0 1 2 3 4 5 6 7 8 9}	135
:RECOOrder[1 2 3 4]:USB <dest>	136
:RECOOrder[1 2 3 4]:PERIod <value>	136
:RECOOrder[1 2 3 4]:PERIod?	137
:RECOOrder[1 2 3 4] [:STATe] {ON OFF}	137
:RECOOrder[1 2 3 4] [:STATe]?	137
:RECOOrder[1 2 3 4]:GRouPs <value>	138
:RECOOrder[1 2 3 4]:GRouPs?	138
:RECOOrder[1 2 3 4]:ENABle {ON OFF}	138
:RECOOrder[1 2 3 4]:ENABle?	138
:SEQUence[1 2]:CYCLEs {N I},{<value>}	138
:SEQUence[1 2]:CYCLEs?	139
:SEQUence[1 2]:ENDState {OFF LAST}	139
:SEQUence[1 2]:ENDState?	139
:SEQUence[1 2]:GRouPs <value>	140
:SEQUence[1 2]:GRouPs?	140
:SEQUence[1 2]:PARAMeter<No>,<volt>,<curr> ,<time>	140
:SEQUence[1 2]:PARAMeter? <No>,<count>	141
:SEQUence[1 2]:STARt <value>	142
:SEQUence[1 2]:STARt?	142
:SEQUence[1 2] [:STATe] {ON OFF}	142
:SEQUence[1 2] [:STATe]?	143
:SEQUence[1 2]:TEMPlEt:CONSTRuct	143
:SEQUence[1 2]:TEMPlEt:FALLRate <value>	143
:SEQUence[1 2]:TEMPlEt:FALLRate?	143
:SEQUence[1 2]:TEMPlEt:INTERval <value>	144
:SEQUence[1 2]:TEMPlEt:INTERval?	144
:SEQUence[1 2]:TEMPlEt:INVErt {ON OFF}	144
:SEQUence[1 2]:TEMPlEt:INVErt?	145
:SEQUence[1 2]:TEMPlEt:MAXValue{<value>	

MINimum MAXimum}	145
:SEQUence[1 2]:TEMPlet:MAXValue?	145
:SEQUence[1 2]:TEMPlet:MINValue{<value>	
MINimum MAXimum}	146
:SEQUence[1 2]:TEMPlet:MINValue?	146
:SEQUence[1 2]:TEMPlet:OBject {V C}	146
:SEQUence[1 2]:TEMPlet:OBject?	147
:SEQUence[1 2]:TEMPlet:POINTs <value>	147
:SEQUence[1 2]:TEMPlet:POINTs?	147
:SEQUence[1 2]:TEMPlet:RISERate <value>	147
:SEQUence[1 2]:TEMPlet:RISERate?	148
:SEQUence[1 2]:TEMPlet:SElect	
{SINE PULSE RAMP UP DN UPDN RISE FALL}	148
:SEQUence[1 2]:TEMPlet:SElect?	148
:SEQUence[1 2]:TEMPlet:SYMMetry <value>	148
:SEQUence[1 2]:TEMPlet:SYMMetry?	149
:SEQUence[1 2]:TEMPlet:WIDTh <value>	149
:SEQUence[1 2]:TEMPlet:WIDTh?	149
:TRIGger:IN[:ENABle] {D0 D1 D2 D3 D4},	
{ON OFF}	149
:TRIGger:IN[:ENABle]?{D0 D1 D2 D3 D4}	150
:TRIGger:IN:RESPOse{D0 D1 D2 D3 D4},	
{ON OFF TOGGLE POWER CV CC CR IND SER	
PAR }	150
:TRIGger:IN:RESPOse? {D0 D1 D2 D3 D4}	151
:TRIGger:IN:SENSitivity	
{D0 D1 D2 D3 D4},{LOW MID HIGH}	152
:TRIGger:IN:SENSitivity?{D0 D1 D2 D3 D4}	152
:TRIGger:IN:SOURce {D0 D1 D2 D3 D4} ,	
{CH1 CH2 CH3 CH4},{ON OFF}	152
: TRIGger:IN:SOURce?{D0 D1 D2 D3 D4}	153
:TRIGger:IN:TYPE	
{D0 D1 D2 D3 D4},{RISE FALL HIGH LOW	
STATE }	153
:TRIGger:IN:TYPE?{D0 D1 D2 D3 D4}	153
:TRIGger:OUT:CONDition	
{D0 D1 D2 D3 D4},{OUTOFF OUTON >V <V	
=V >C <C =C >P <P =P AUTO},<value>	154
:TRIGger:OUT:CONDition? {D0 D1 D2 D3 D4}	155
:TRIGger:OUT[:ENABle]	
{D0 D1 D2 D3 D4},{ON OFF}	155

	:TRIGger:OUT[:ENABle]? {D0 D1 D2 D3 D4}	156
	:TRIGger:OUT:POLARity	
	{D0 D1 D2 D3 D4},{POSitive NEGAtive}	156
	:TRIGger:OUT:POLARity? {D0 D1 D2 D3 D4}	156
	:TRIGger:OUT:SOURce	
	{D0 D1 D2 D3 D4},{CH1 CH2 CH3 CH4}	157
	:TRIGger:OUT:SOURce? {D0 D1 D2 D3 D4}	157
<hr/>		
Status	STATUS?	158
Commands	:STATus:PRESet	159
	:STATus:OPERation[:EVENT]?	159
	:STATus:OPERation:CONDition?	159
	:STATus:OPERation:ENABle <NRf>	159
	:STATus:OPERation:ENABle?	160
	:STATus:MEASurement[:EVENT]?	160
	:STATus:MEASurement:ENABle <NRf>	160
	:STATus:MEASurement:ENABle?	161
	:STATus:MEASurement:CONDition?	161
	:STATus:QUEStionable[:EVENT]?	161
	:STATus:QUEStionable:CONDition?	161
	:STATus:QUEStionable:ENABle <NRf>	162
	:STATus:QUEStionable:ENABle?	162
	:STATus:QUEue[:NEXT]?	162
	:STATus:QUEue:ENABle <list>	162
	:STATus:QUEue:ENABle?	163
	:STATus:QUEue:DISable <list>	163
	:STATus:QUEue:DISable?	164
	:STATus:QUEue:CLEar	164
	<hr/>	
System	:SYSTEM:VERSion?	166
Commands	:SYSTEM:ERRor?	166
	:SYSTEM:ERR?	166
	:SYSTEM:CLEar	167
	:SYSTEM:POSetup <name>	167
	:SYSTEM:POSetup?	167
	:SYSTEM:COMMunicate:LAN:DHCP[:STATe] 	167
	:SYSTEM:COMMunicate:LAN:DHCP[:STATe]?	168
	:SYSTEM:COMMunicate:LAN:IPADdress	
	<IPaddress>	168
	:SYSTEM:COMMunicate:LAN:IPADdress?	168
	:SYSTEM:COMMunicate:LAN:SMASk<mask>	169

	:SYSTem:COMMunicate:LAN:SMASK?	169
	:SYSTem:COMMunicate:LAN:GATEway	
	<IPaddress>	169
	:SYSTem:COMMunicate:LAN:GATEway?	170
	:SYSTem:COMMunicate:LAN:MANualip	
	[[:STATe] 	170
	:SYSTem:COMMunicate:LAN:MANualip	
	[[:STATe]?	170
	:SYSTem:COMMunicate:LAN:APPLY	170
	:SYSTem:REMote	171
	REMote	171
	:SYSTem:BEEPer:STATe 	171
	BEEP<Boolean>	171
	:SYSTem:BEEPer:STATe?	172
	:SYSTem:LOCAl	172
	LOCAl	172
	:SYSTem:INTerface [USB RS232 GPIB LAN]	172
	:SYSTem:LANGuage [CHINese ENGLISH]	172
	:SYSTem:LANGuage?	173
	:SYSTem:BAUDrate:USB[9600 19200 38400	
	57600 115200]	173
	:SYSTem:BAUDrate:USB?	173
	BAUD<NR1>	173
	HELP?	174
<hr/>		
System Related	*IDN?	175
Commands	*RST	175
	*SAV<NRf>	176
	SAV<NR1>	176
	*RCL<NRf>	176
	RCL <NR1>	176
<hr/>		
Status Byte	*SRE <Allowed values>	184
Register	*SRE?	184
Commands	*STB?	184
<hr/>		
Status Event	*ESE <Allowed Values>	186
Register	*ESE?	186
Commands	*ESR?	186
<hr/>		
Other Status	*CLS	187

Register	*OPC	187
Commands	*OPC?	187

Command Details

When using commands to select a specific channel, [1] stands for CH1, [2] stands for CH2, [3] stands for CH3, [4] stands for CH4. "1" can be omitted when you want to select CH1 as it is selected by default. However if you wish to select CH2, "2" must be selected.

Measurement Commands

:MEASure[1 2 3 4] :<function>?	107
VOUT<X>?	107
IOUT<X>?	108

:MEASure[1|2|3|4] :<function>?

Description	Performs a "READ?" query on the specified measurement function.						
Parameter	<table> <tr> <td><function></td> <td>CURRENT[:DC]:Measures the current.</td> </tr> <tr> <td></td> <td>VOLTage[:DC]:Measures the voltage.</td> </tr> <tr> <td></td> <td>POWER[:DC]:Measures the power.</td> </tr> </table>	<function>	CURRENT[:DC]:Measures the current.		VOLTage[:DC]:Measures the voltage.		POWER[:DC]:Measures the power.
<function>	CURRENT[:DC]:Measures the current.						
	VOLTage[:DC]:Measures the voltage.						
	POWER[:DC]:Measures the power.						
Example	:MEASure2: CURRENT? Reads back the CH2 current value.						

VOUT<X>?

Description	Returns the actual output voltage.								
Parameter	<table> <tr> <td>1</td> <td>CH1</td> </tr> <tr> <td>2</td> <td>CH2</td> </tr> <tr> <td>3</td> <td>CH3 (for T3PS43203P only)</td> </tr> <tr> <td>4</td> <td>CH4 (for T3PS43203P only)</td> </tr> </table>	1	CH1	2	CH2	3	CH3 (for T3PS43203P only)	4	CH4 (for T3PS43203P only)
1	CH1								
2	CH2								
3	CH3 (for T3PS43203P only)								
4	CH4 (for T3PS43203P only)								

Example VOUT1?
 Returns the CH1 output voltage

IOUT<X>?

Description Returns the actual output current.

Parameter	X	1=CH1 2=CH2 3=CH3 (for T3PS43203P only) 4=CH4 (for T3PS43203P only)
-----------	---	--

Example IOUT1?
 Returns the CH1 output voltage

Display Commands

:DISPlay:ENABle	109
:DISPlay:ENABle?	109
:DISPlay:BRIGhtness <NRf>	109
:DISPlay: BRIGhtness?.....	110
:DISPlay:TYPE {1 2 3 4 5 6 7}	110
:DISPlay:TYPE?	110

:DISPlay:ENABle

Description	Turn the LCD display on or off.	
Parameter	0/OFF	Turns the display off
	1/ON	Turns the display on.
Example	:DISPlay:ENABle ON Turns the LCD display on.	

:DISPlay:ENABle?

Description	Queries the state of the display.
Example	:DISPlay:ENABle? Returns the state of the display.

:DISPlay:BRIGhtness <NRf>

Description	Sets backlight display brightness.	
Parameter	<NRf>	Low
		Middle
		High
		CH4 (for T3PS43203P only)

Example :DISPlay: BRIGhtness Low
 Sets the backlight to Low.

:DISPlay: BRIGhtness?

Description Queries the brightness of the display.

Example :DISPlay: BRIGhtness?
 Returns the brightness of the display.

:DISPlay:TYPE {1|2|3|4|5|6|7}

Description Sets the display screens. For details, see page 29.

Example :DISPlay:TYPE 4
 Sets the display screens of TYPE4.

:DISPlay:TYPE?

Description Queries the TYPE of display screens.

Example :DISPlay:TYPE?
 Returns the TYPE of display screens.

Output Commands

:OUTPut[1 2 3 4][:STATe] 	111
:OUTPut[1 2 3 4][:STATe]?	111
ALLOUTON	112
ALLOUTOFF	112
OUT<Boolean>	112
:OUTPut[1 2 3 4]:OVP:STATe	112
:OUTPut[1 2 3 4]:OVP:STATe?	113
:OUTPut[1 2 3 4]:OVP <value>.....	113
:OUTPut[1 2 3 4]:OVP?	113
:OUTPut[1 2 3 4]:OCP:STATe 	113
:OUTPut[1 2 3 4]:OCP:STATe?	114
:OUTPut[1 2 3 4]:OCP <value>.....	114
:OUTPut[1 2 3 4]:OCP?	114

:OUTPut[1|2|3|4][:STATe]

Description	Turns the output on or off.	
Parameter		0/OFF: Turn off the output 1/ON: Turn on the output
Example	:OUTPut:STATe ON Turns on the output of CH1 on.	

:OUTPut[1|2|3|4][:STATe]?

Description	Queries the output state.
Example	:OUTPut:STATe? Returns the output state of CH1.

ALLOUTON

Description	Turns the channels output on.
Example	ALLOUTON Turns the channels output on.

ALLOUTOFF

Description	Turns the channels output off.
Example	ALLOUTOFF Turns the channels output off.

OUT<Boolean>

Description	Turns the output on or off.
Parameter	< Boolean > 0= off 1=on
Example	OUT1 Turns on the output

:OUTPut[1|2|3|4]:OVP:StAtE

Description	Turns OVP protection on/off
Parameter	< b> 0/OFF:Turns OVP off. 1/ON:Turns OVP on
Example	:OUTPut2:OVP:StAtE ON Turn on OVP on CH2.

:OUTPut[1|2|3|4]:OVP:STATe?

Description	Queries the status of the OVP function.
Example	:OUTPut2:OVP:STATe? Returns the status of the OVP function on CH2.

:OUTPut[1|2|3|4]:OVP <value>

Description	Sets the OVP level.
Parameter	< value > CH1 0.50-35.00V CH2 0.50-35.00V CH3 0.50-5.50V(T3PS43203P) CH4 0.50-16.50V(T3PS43203P)
Example	:OUTPut2:OVP 10.05 Sets the OVP voltage to 10.05V for CH2

:OUTPut[1|2|3|4]:OVP?

Description	Queries the OVP current level.
Example	:OUTPut2:OCP? Queries the OVP current level on CH2.

**:OUTPut[1|2|3|4]:OCP:STATe **

Description	Turns OCP protection on/off
Parameter	< b> 0/OFF:Turns OCP off. 1/ON:Turns OCP on
Example	:OUTPut2:OCP:STATe ON Turn on OCP on CH2.

:OUTPut[1|2|3|4]:OCP:STATe?

Description Queries the status of the OCP function.

Example :OUTPut2:OCP:STATe?
Returns the status of the OCP function on CH2.

:OUTPut[1|2|3|4]:OCP <value>

Description Sets the OCP level.

Parameter	< value >	CH1 0.05-3.50A
		CH2 0.05-3.50A
		CH3 0.05-1.20A(T3PS43203P)
		CH4 0.05-1.20A(T3PS43203P)

Example :OUTPut2:OVP 1.5
Sets the OVP voltage to 1.5A for CH2

:OUTPut[1|2|3|4]:OCP?

Description Queries the OCP current level.

Example :OUTPut2:OCP?
Queries the OCP current level on CH2.

Source and Load Commands

:SOURce[1 2 3 4]:CURRent <NRf>	118
ISET<X>:<NR2>	118
:SOURce[1 2 3 4]:CURRent?	119
ISET<X>?	119
:SOURce[1 2 3 4]:CURRent[:LIMit]:STATe?	119
:SOURce[1 2 3 4]:VOLTage <NRf>	120
VSET<X>:<NR2>	120
:SOURce[1 2 3 4]: VOLTage?	120
VSET<X>?	120
:SOURce[1 2]:RESistor < NRf >	121
:SOURce[1 2]:RESistor?	121
:OUTPut:SERies {ON OFF}	121
:OUTPut:PARAllel {ON OFF}	121
TRACK<NR1>	122
:LOAD[1 2]:CV{ON OFF}	122
:LOAD[1 2]:CC{ON OFF}	122
:LOAD[1 2]:CR{ON OFF}	122
:MODE[1 2]?	123
:LOAD[1 2]:RESistor <NRf>	123
:LOAD[1 2]:RESistor?	123
:DELAy[1 2]:CYCLEs {N 1}[,<value>]	123
:DELAy[1 2]:CYCLEs?	124
:DELAy[1 2]:ENDState {ON OFF LAST}	124
:DELAy[1 2]:ENDState?	124
:DELAy[1 2]:GROUPs <NRf>	124
:DELAy[1 2]:GROUPs?	125
:DELAy[1 2]:PARAMeter <No>,{ON OFF},<time> ..	125
:DELAy[1 2]:PARAMeter? <No>[,<count>]	125
:DELAy [1 2]:STARt <value>	126
:DELAy [1 2]:STARt?	126
:DELAy[1 2] [:STATe]{ON OFF}	126
:DELAy[1 2] [:STATe]?	127
:DELAy[1 2]:STATe:GENErate {01P 10P}	127
:DELAy[1 2]:STATe: GENErate?	127
:DELAy[1 2]:STOP{NONE <V>V =V <C>C =C <P	
>P =P}[,<value>]	127
:DELAy[1 2]:STOP?	128
:DELAy[1 2]:TIME:GENErate	

{FIX INC DEC}{,<value0>,<value1>}]	129
:DELAy[1 2]:TIME:GENERate?	130
:MONItor[1 2 3 4]:CURRent:CONDition{<C>>C =C NONE},{AND OR NONE}	130
:MONItor[1 2 3 4]:CURRent:CONDition?	131
:MONItor[1 2 3 4]:CURRent[:VALue]{<value> MINimum MAXimum}	131
:MONItor[1 2 3 4]:CURRent[:VALue]?	131
:MONItor[1 2 3 4]:POWER:CONDition {<P>>P =P NONE}	132
:MONItor[1 2 3 4]:POWER:CONDition?	132
:MONItor[1 2 3 4]:POWER[:VALue]{<value> MINimum MAXimum}	132
:MONItor[1 2 3 4]:POWER[:VALue]?	133
:MONItor[1 2 3 4][:STATe] {ON OFF}	133
:MONItor[1 2 3 4][:STATe]?	133
:MONItor[1 2 3 4]:STOPWay{OUTOFF ALARM BEEPER},{ON OFF}	133
:MONItor[1 2 3 4]:STOPWay?	134
:MONItor[1 2 3 4]:VOLTage:CONDition{<V>>V =V NONE},{AND OR NONE}	134
:MONItor[1 2 3 4]:VOLTage:CONDition?	134
:MONItor[1 2 3 4]:VOLTage[:VALue]{<value> MINimum MAXimum}	135
:MONItor[1 2 3 4]:VOLTage[:VALue]?	135
:RECOOrder[1 2 3 4]:PATH?	135
:RECOOrder[1 2 3 4]:MEMory{0 1 2 3 4 5 6 7 8 9}	135
:RECOOrder[1 2 3 4]:USB <dest>	136
:RECOOrder[1 2 3 4]:PERIod <value>	136
:RECOOrder[1 2 3 4]:PERIod?	137
:RECOOrder[1 2 3 4][:STATe] {ON OFF}	137
:RECOOrder[1 2 3 4][:STATe]?	137
:RECOOrder[1 2 3 4]:GROUPs <value>	138
:RECOOrder[1 2 3 4]:GROUPs?	138
:RECOOrder[1 2 3 4]:ENABle {ON OFF}	138
:RECOOrder[1 2 3 4]:ENABle?	138
:SEQUence[1 2]:CYCLEs {N I},{<value>}	138
:SEQUence[1 2]:CYCLEs?	139
:SEQUence[1 2]:ENDState {OFF LAST}	139
:SEQUence[1 2]:ENDState?	139
:SEQUence[1 2]:GROUPs <value>	140

:SEQUence[1 2]:GROUPs?	140
:SEQUence[1 2]:PARAMeter<No>,<volt>,<curr> ,<time>	140
:SEQUence[1 2]:PARAMeter? <No>,<count>	141
:SEQUence[1 2]:STARt <value>	142
:SEQUence[1 2]:STARt?	142
:SEQUence[1 2][:STATe] {ON OFF}	142
:SEQUence[1 2][:STATe]?	143
:SEQUence[1 2]:TEMPlet:CONSTRuct	143
:SEQUence[1 2]:TEMPlet:FALLRate <value>	143
:SEQUence[1 2]:TEMPlet:FALLRate?	143
:SEQUence[1 2]:TEMPlet:INTERval <value>	144
:SEQUence[1 2]:TEMPlet:INTERval?	144
:SEQUence[1 2]:TEMPlet:INVErt {ON OFF}	144
:SEQUence[1 2]:TEMPlet:INVErt?	145
:SEQUence[1 2]:TEMPlet:MAXValue{<value> MINimum MAXimum}	145
:SEQUence[1 2]:TEMPlet:MAXValue?	145
:SEQUence[1 2]:TEMPlet:MINValue{<value> MINimum MAXimum}	146
:SEQUence[1 2]:TEMPlet:MINValue?	146
:SEQUence[1 2]:TEMPlet:OBject {V C}	146
:SEQUence[1 2]:TEMPlet:OBject?	147
:SEQUence[1 2]:TEMPlet:POINTs <value>	147
:SEQUence[1 2]:TEMPlet:POINTs?	147
:SEQUence[1 2]:TEMPlet:RISERate <value>	147
:SEQUence[1 2]:TEMPlet:RISERate?	148
:SEQUence[1 2]:TEMPlet:SElect {SINE PULSE RAMP UP DN UPDN RISE FALL}....	148
:SEQUence[1 2]:TEMPlet:SElect?	148
:SEQUence[1 2]:TEMPlet:SYMMetry <value>	148
:SEQUence[1 2]:TEMPlet:SYMMetry?	149
:SEQUence[1 2]:TEMPlet:WIDTh <value>	149
:SEQUence[1 2]:TEMPlet:WIDTh?	149
:TRIGger:IN[:ENABle] {D0 D1 D2 D3 D4}, {ON OFF}	149
:TRIGger:IN[:ENABle]?{D0 D1 D2 D3 D4}	150
:TRIGger:IN:RESPonse{D0 D1 D2 D3 D4}, {ON OFF TOGGLE POWER CV CC CR IND SER PAR }	150
:TRIGger:IN:RESPonse? {D0 D1 D2 D3 D4}	151

:TRIGger:IN:SENSitivity
 {D0|D1|D2|D3|D4},{LOW|MID|HIGH} 152
 :TRIGger:IN:SENSitivity?{D0|D1|D2|D3|D4} 152
 :TRIGger:IN:SOURce {D0|D1|D2|D3|D4} ,
 {CH1|CH2|CH3|CH4},{ON|OFF} 152
 :TRIGger:IN:SOURce?{D0|D1|D2|D3|D4} 153
 :TRIGger:IN:TYPE
 {D0|D1|D2|D3|D4},{RISE|FALL|HIGH|LOW
 |STATE } 153
 :TRIGger:IN:TYPE?{D0|D1|D2|D3|D4} 153
 :TRIGger:OUT:CONDition
 {D0|D1|D2|D3|D4},{OUTOFF|OUTON}>V|<V|=V
 |>C|<C|=C|>P|<P|=P|AUTO},{<value> 154
 :TRIGger:OUT:CONDition? {D0|D1|D2|D3|D4} 155
 :TRIGger:OUT[:ENABle]
 {D0|D1|D2|D3|D4},{ON|OFF} 155
 :TRIGger:OUT[:ENABle]?{D0|D1|D2|D3|D4} 156
 :TRIGger:OUT:POLArity
 {D0|D1|D2|D3|D4},{POSitive|NEGAtive} 156
 :TRIGger:OUT:POLArity? {D0|D1|D2|D3|D4} 156
 :TRIGger:OUT:SOURce
 {D0|D1|D2|D3|D4},{CH1|CH2|CH3|CH4} 157
 :TRIGger:OUT:SOURce?{D0|D1|D2|D3|D4} 157

:SOURce[1|2|3|4]:CURRent <NRf>

Description	Sets the current level.	
Parameter	<NRf>	0.0000-6.2000
Example	:SOURce2:CURRent 1.0005 Sets the current level to 1.0005A for CH2.	

ISET<X>:<NR2>

Description	Sets the current level.	
Parameter	<X>	1= CH1 2= CH2

	3= CH3 (for T3PS43203P only)
	4= CH4 (for T3PS43203P only)
	<NR2> Decimal number, range 0-6.200A
Example	<p>ISET1:2.234</p> <p>Sets the CH1 output current to 2.234A.</p>

:SOURce[1|2|3|4]:CURRent?

Description	Queries the current limit level.
Example	<p>:SOURce2:CURRent?</p> <p>Queries the current limit level on CH2.</p>

ISET<X>?

Description	Returns the output current setting.
Parameter	<p><X> 1= CH1</p> <p>2= CH2</p> <p>3= CH3 (for T3PS43203P only)</p> <p>4= CH4 (for T3PS43203P only)</p>
Example	<p>ISET1?</p> <p>Returns the CH1 output current setting.</p>

:SOURce[1|2|3|4]:CURRent[:LIMit]:STATe?

Description	Queries the current limit state. Returns CV if the current limit has not been reached, returns CC if the current limit has been reached.
Example	<p>:SOURce2:CURRent:STATe?</p> <p>Queries the current limit state of CH2.</p>

:SOURce[1|2|3|4]:VOLTage <NRf>

Description	Sets the output voltage amplitude.	
Parameter	<NRf>	0.000-MAX
Example	:SOURce2:VOLTage 5.321 Sets the output voltage to 5.321V for CH2	

VSET<X>:<NR2>

Description	Sets the voltage level.	
Parameter	<X>	1= CH1 2= CH2 3= CH3 (for T3PS43203P only) 4= CH4 (for T3PS43203P only)
	<NR2>	Decimal number, range 0-32.000V
Example	VSET1:20.345 Sets the CH1 voltage to 20.345V	

:SOURce[1|2|3|4]: VOLTage?

Description	Queries the output voltage setting.	
Example	:SOURce2:VOLTage? Queries the output voltage setting on CH2.	

VSET<X>?

Description	Returns the output voltage setting.	
Parameter	<X>	1= CH1 2= CH2 3= CH3 (for T3PS43203P only)

4= CH4 (for T3PS43203P only)

Example VSET1?
Returns the CH1 output voltage setting.

:SOURce[1|2]:RESistor < NRF >

Description Set the resistor value

Parameter <NRF> 1-1000

Example :SOURce2: RESistor 1000
Set the resistor value as 1000Ω for CH2

:SOURce[1|2]:RESistor?

Description Queries the setting resistor value.

Example :SOURce2: RESistor?
Queries the setting resistor value and returns the readback value for CH2.

:OUTPut:SERies {ON|OFF}

Description Sets CH1/CH2 as tracking series mode.

Example :OUTPut:SERies ON
Sets CH1/CH2 as Tracking series mode.

:OUTPut:PARAllel {ON|OFF}

Description Sets CH1/CH2 as tracking parallel mode.

Example :OUTPut:PARAllel ON
Sets CH1/CH2 as tracking parallel mode.

TRACK<NR1>

Description	Selects the operation mode: independent, tracking series, or tracking parallel
Parameter	<NR1> 0: Independent, 1: Series, 2: Parallel
Example	TRACK0 Selects the independent mode.

:LOAD[1|2]:CV{ON|OFF}

Description	Sets CH1/CH2 as Load CV mode.
Example	:LOAD2:CV ON Sets CH2 as Load CV mode.

:LOAD[1|2]:CC{ON|OFF}

Description	Sets CH1/CH2 as Load CC mode.
Example	:LOAD2:CC ON Sets CH2 as Load CC mode.

:LOAD[1|2]:CR{ON|OFF}

Description	Sets CH1/CH2 as Load CR mode.
Example	:LOAD2:CR ON Sets CH2 as Load CR mode.

:MODE[1|2]?

Description	Queries CH1 or CH2 work mode. 6 modes below: SERIES, PARAllel, INDE pendent, CV Load, CC Load, CR Load
Example	:MODE1? Queries CH1 work mode.

:LOAD[1|2]:RESistor <NRF>

Description	Sets the Load CR level.
Parameter	<value> 1-1000
Example	:LOAD2: RESistor 100 Sets the Load CR level to 100 Ω for CH2.

:LOAD[1|2]:RESistor?

Description	Queries the Load CR level.
Parameter	<value> 1-1000
Example	:LOAD2: RESistor? Return the Load CR level for CH2.

:DELAy[1|2]:CYCLEs {N|I},<value>

Description	Sets the cycle number of Delay.
Parameter	<value> 50-1000. I represents an infinite loop. N represents a finite loop. is set by parameter <value>.

Example	:DELAy2:CYCLEs N,100 Sets the cycle number of Delay as 100 for CH2.
---------	--

:DELAy[1|2]:CYCLEs?

Description	Queries the cycle number of Delay.
Example	:DELAy2:CYCLEs? Return to I or N, <value> for CH2 (For example: N,100)

:DELAy[1|2]:ENDState {ON|OFF|LAST}

Description	Sets the termination state of Delay.	
Parameter	ON	Output enabled
	OFF	Output disabled
	LAST	Stay at the last group of output state.
Example	:DELAy2: ENDState OFF Sets the termination state of Delay as output disabled for CH2.	

:DELAy[1|2]:ENDState?

Description	Queries the termination state of Delay.	
Parameter	ON	Output enabled
	OFF	Output disabled
	LAST	Stay at the last group of output state.
Example	:DELAy2: ENDState? Return the termination state of Delay for CH2.	

:DELAy[1|2]:GROUPs <NRf>

Description	Sets the output number of Delay.	
Parameter	<NRf>	1 - 2048

Example :DELAy2:GROUPs 100
Sets the output number of Delay as 100 for CH2.

:DELAy[1|2]:GROUPs?

Description Queries the output number of Delay.

Example :DELAy2:GROUPs?
Return the output number of Delay for CH2.

:DELAy[1|2]:PARAMeter <No>,{ON|OFF},<time>

Description Sets the delay parameter of Delay.

Parameter	<No>	Integer 0-2047. Sets the serial number of delay parameter.
	ON OFF	The output state of the group
	<time>	Integer 1s-300s. The delay duration of the group.

Example :DELAy2:PARAMeter 1,ON,10
Sets the delay parameter of Delay as the 1st group, output ON, delay 10s for CH2.

:DELAy[1|2]:PARAMeter? <No>[,<count>]

Description Queries the delay parameter of the specified groups of Delay.

Parameter	<No>	Integer 0-2047. Sets the serial number of the delay parameter.
-----------	------	--

Example :DELAy2:PARAMeter? 2,2

Return the delay parameter of 2 groups of Delay for CH2. From the second group.

The format of delay parameter of each group is “serial number, output state, delay duration”, and every group of parameter is divided by semicolon“;”. For instance, “2, OFF, 3;3, ON,1;” representing the delay parameters of 2 groups; the serial number of delay parameter of the 1st group is 2, output state is OFF, delay time is 3S; the 2nd group is 3, output state is ON, delay time is 1S.

:DELAy [1|2]:STARTt <value>

Description Sets the sequence number for initial execution.

Parameter <NRf> 0 - 2047

Example :DELAy2:START?

Sets the CH2 sequence output to start from the group 10.

:DELAy [1|2]:START?

Description Queries the sequence number for initial execution of the channel delay output.

Example :DELAy 2:START?

Returns the initial sequence number of CH2 sequence output.

:DELA y[1|2] [:STATe]{ON|OFF}

Description Enable or disable the delay output function of the active channel.

Parameter ON OFF Output state of the group

Example :DELAy2 ON
 Enable the delay output function for CH2.

:DELA y[1|2] [:STATe]?

Description Queries whether the output function of Delay has been enabled or disabled.

Example :DELAy2:STATe?
 Return whether the output function of Delay has been enabled or disabled for CH2.

:DELAy[1|2]:STATe:GENERate {01P|10P}

Description Selects the used pattern of the automatically generated state.

Parameter 01P 10P: the automatically generated state will repeat by the sequence of Off and the On. The automatically generated state will repeat by the sequence of On and the Off.

Example :DELAy2:STATe:GENE 01P
 The automatically generated state will repeat by the sequence of Off and the On for CH2.

:DELAy[1|2]:STATe: GENERate?

Description Queries the currently used pattern of the automatically generated state.

Example :DELAy2:STATe:GENE?
 Queries the currently used pattern of the automatically generated state for CH2.

:DELAy[1|2]:STOP{NONE|<V|>V|=V|<C|>C|=C|<P|>P|=P}[, <value>]

Description	Sets the stop condition of delay.	
Parameter	<V	Sets stop condition type as "<voltage" >voltage" "=voltage".
	>V	
	=V	
	<C	Sets stop condition type as "<current" >current" "=current".
	>C	
	=V	
	<P	Sets stop condition type as "<power" >power" "=power".
>P		
=P		
	<value>	It is used to set voltage, current or power value of stop condition, which range from 0 to the maximum voltage/current/power value of the active channel.
Example	:DELAy2:STOP >V,8 Sets the stop condition of delay as >8V for CH2.	
Note	Sets stop condition type as "NONE".	

:DELA y[1|2]:STOP?

Description	Queries the stop condition of the current delay.
Example	:DELAy2:STOP? Queries the current stop condition, back to NONE or stop condition value.

:DELA y[1|2]:TIME:GENERate
 {FIX|INC|DEC}[,<value0>[,<value1>]]

Description	Sets the method of automatically generated time and the corresponding parameter of delay.
Parameter	<p><value0> The duration of "ON" state. <value1> The duration of "OFF" state.</p> <p>FIX (fixed time) sets <value0> and <value1> time, which ranges from 1s to 300s. The default setting of delay time is enabled when only a time parameter is specified.</p> <p>Constant duration will be generated by the pattern of either monotonous increase or monotonous decrease when INC (monotonous increase) or DEC (monotonous decrease) is set. Starting from the base time, it gradually increases or decreases by steps and further generates duration. Base time (<value0>) and step value (<value1>) are available for setting, the mechanical relation of both of which is base time + output group number * step value ≤ 300s. The available range of setting value for <value0> is from 1s to (300s-output group number * step value). The available range of setting value for <value1> is from 1s- int{(300s-base time/output group number)}. The default duration is base time when only a time parameter is specified.</p>
Example	<p>:DELAy2:TIME:GENE INC,3,5</p> <p>Sets the CH2 method of automatically generated time for delay as monotonous increase, base time as 3s, step value as 5s.</p>

:DELAy[1|2]:TIME:GENERate?

Description	Queries the method of automatically generated time for delay and the corresponding parameter.
Example	:DELAy2:TIME:GENE? Queries the CH2 method of automatically generated time for delay and the corresponding parameter. Return a string with format consisting of the method of automatically generated time, <value0>,<value1>.

:MONItor[1|2|3|4]:CURRent:CONDition {<C|>C|=C|NONE}
,{AND|OR|NONE}

Description	Sets the current monitor condition for monitor (current channel).	
Parameter	<C	Sets the current monitor condition as "<<C"> (<current), ">C" (>current), "NONE" (=current) or "NONE" (current not monitored).
	>C	
	NONE	
	AND	Practical monitor condition is the logical composition of voltage, current and power. , "AND" (and), "OR" (or), "NONE" (none-logical pattern)
	OR	
	NONE	
Example	:MONItor2:CURRent:CONDition <C,AND Sets the CH2current monitor condition for monitor as <current, and the logical pattern as "and".	

:MONItor[1|2|3|4]:CURRent:CONDition?

Description	Queries the current monitor condition for monitor (active channel).
Example	:MONItor2:CURRent:CONDition? Queries the CH2 current monitor condition for monitor. Returns to the current monitor condition and logical pattern.

:MONItor[1|2|3|4]:CURRent[:VALue]{<value>|MINimum|MAXimum}

Description	Queries the current monitor value for monitor (active channel).
Parameter	<value> The range available is from 0 to the maximum current value of active channel.
Example	:MONItor2: CURRent 2 Sets CH2current monitor value for monitor as 2A.

:MONItor[1|2|3|4]:CURRent[:VALue]?

Description	Queries the current monitor value for current monitor (active channel).
Example	:MONItor2: CURRent? Queries the CH2 current monitor value for current monitor. Returns to the current monitor value of current monitor.

:MONItor[1|2|3|4]:POWER:CONDition {<P|>P||=P|NONE}

Description	Sets the power monitor condition for monitor (active channel).	
Parameter	<P >P NONE	Sets power monitor condition as “<P” (<power), “>P” (>power), “=P” (=power) or “NONE” (none-monitored power)
Example	:MONItor2:POWER: CONDition <P Sets the CH2 power monitor condition of monitor as <power.	

:MONItor[1|2|3|4]:POWER:CONDition?

Description	Queries the power monitor condition of current monitor.	
Example	:MONItor2:POWER:COND? Queries the CH2power monitor condition of current monitor.	

:MONItor[1|2|3|4]:POWER[:VALue]{<value>|MINimum|MAXimum}

Description	Sets the power monitor value for monitor (active channel).	
Parameter	<value>	Ranges from 0 to the maximum power value of the active channel.
Example	:MONItor2:POWER 20 Sets the CH2 power monitor value for monitor as 20W.	

:MONItor[1|2|3|4]:POWER[:VALue]?

Description	Sets the power monitor value for monitor (active channel).
Example	:MONItor2:POWER? Queries the CH2 power monitor value for current monitor.

:MONItor[1|2|3|4] [:STATe] {ON|OFF}

Description	Enable or disable monitor (active channel)
Example	:MONItor2 ON Enable monitor for CH2

:MONItor[1|2|3|4] [:STATe]?

Description	Queries whether the current monitor is On or Off (active channel).
Example	:MONItor2? Queries whether the current monitor is On or Off of CH2. Returns to ON or OFF.

:MONItor[1|2|3|4]:STOPway{OUTOFF|ALARM |BEEPER},{ON|OFF}

Description	Sets the stop method of monitor (active channel).
Parameter	{OUTOFF ALARM BEEPER} Disable output by set stop method (OUTOFF), warning (ALARM) or beep (BEEPER).
Example	:MONItor2: STOPway ALARM,ON Enable stop method of “warning” for CH2.

:MONItor[1|2|3|4]:STOPway?

Description	Queries the stop method for current monitor (active channel).
Example	:MONItor2:STOPway? Queries the CH2 stop method state of current monitor. Returns to the on & off state of the 3 stop methods.

:MONItor[1|2|3|4]:VOLTage:CONDition{<V|>V|=V|NONE},{AND|OR|NONE}

Description	Queries the voltage monitor condition of monitor (active channel).										
Parameter	<table border="0"> <tr> <td><V</td> <td>Sets voltage monitor condition as “<V”</td> </tr> <tr> <td>>V</td> <td>(<voltage), “ >V” (>voltage) , “=V”</td> </tr> <tr> <td>NONE</td> <td>(=voltage) or “ NONE” (none-monitored voltage)</td> </tr> <tr> <td>AND</td> <td rowspan="3">Practical monitor condition is the logical composition of voltage, current and power. , “AND ” (and), “OR” (or), “NONE” (none-logical pattern)</td> </tr> <tr> <td>OR</td> </tr> <tr> <td>NONE</td> </tr> </table>	<V	Sets voltage monitor condition as “<V”	>V	(<voltage), “ >V” (>voltage) , “=V”	NONE	(=voltage) or “ NONE” (none-monitored voltage)	AND	Practical monitor condition is the logical composition of voltage, current and power. , “AND ” (and), “OR” (or), “NONE” (none-logical pattern)	OR	NONE
<V	Sets voltage monitor condition as “<V”										
>V	(<voltage), “ >V” (>voltage) , “=V”										
NONE	(=voltage) or “ NONE” (none-monitored voltage)										
AND	Practical monitor condition is the logical composition of voltage, current and power. , “AND ” (and), “OR” (or), “NONE” (none-logical pattern)										
OR											
NONE											
Example	:MONItor2: VOLTage:CONDition <V,AND Sets the CH2 voltage monitor condition of monitor (active channel) as “<voltage,and”.										

:MONItor[1|2|3|4]:VOLTage:CONDition?

Description	Queries the voltage monitor condition for the current monitor (active channel).
Example	:MONItor2:VOLTage:CONDition? Queries the CH2 voltage monitor condition for the current monitor.

:MONItor[1|2|3|4]:VOLTage[:VALue]{<value>|MINimum|MAXimum}

Description	Sets the voltage monitor value of monitor (active channel)
Parameter	<value> Ranges from 0 to the maximum voltage value of the active channel.
Example	:MONItor2: VOLTage 5 Sets the CH2 voltage monitor value of monitor as 5V (active channel).

:MONItor[1|2|3|4]:VOLTage[:VALue]?

Description	Queries the voltage monitor value of monitor (active channel).
Example	:MONItor2: VOLTage? Queries the CH2 voltage monitor value for the current monitor.

:RECOOrder[1|2|3|4]:PATH?

Description	Queries the save location of recorded file
Example	:RECOOrder2:PATH? Queries the save location of recorded file for CH2.

:RECOOrder[1|2|3|4]:MEMOry{0|1|2|3|4|5|6|7|8|9}

Description	Save the recorded file with specified name to the internal storage with specified saving location.
Parameter	{0 1 2 3 4 5 6 7 8 9} represents 10 individual saving locations of recorded file within internal storage.

Example :RECOOrder2:MEMory 5
 Save the CH2 recorded file to the saving location of recorded file within the internal storage 5.

:RECOOrder[1|2|3|4]:USB <dest>

Description Save the recorded file to the specified location within the external storage.

Parameter <dest> Represents the specified location within the external storage with specific formate usb:\<name>.CSV. The length is limited to 8 characters. Filename comes with .CSV as the surffix, which can be omitted.

Example :RECOOrder2:USB:\R001.CSV
 Save the CH2 recorded file with specified name "R001.CSV" to the enternal storage.To set record period and saving location is Not permitted when recorder is enabled. Therefore, preset saving location is required prior to enabling recorder. Instrument will automatically save recorded file with specified name to the specified saving location when recorder is disabled.

:RECOOrder[1|2|3|4]:PERIod <value>

Description Sets the record period of recorder.

Parameter <value> Ranges from 1s to 300s. Instrument samples and saves output intervals of each channel when recorder is enabled.

Example :RECOOrder2:PERIod 5
 Sets the CH2 recorded period of recorder as 5s.

:RECOOrder[1|2|3|4]:PERIOD?

Description	Sets the recorded period of recorder.
Example	:RECOOrder2:PERIOD? Queries the CH2 recorded period for the current recorder. Returns to integer between 1 and 300.

:RECOOrder[1|2|3|4] [:STATE] {ON|OFF}

Description	<p>Enable or disable recorder.</p> <p>When recorder is enabled, it is Not allowed to set record period and saving location and instrument will sample and save output of each channel based on the interval of currently set recorded period.</p> <p>Make sure output of each channel is enabled during recording process. For those disabled output channels, the corresponding record data turn to 0 overall. When recorder is disabled, recording process terminates and instrument will automatically save recorded file to the currently set saving location.</p>
Example	:RECOOrder2 ON Enable recorder for CH2

:RECOOrder[1|2|3|4] [:STATE]?

Description	Queries the current recorder state.
Example	:RECOOrder2? Queries the state of CH2 recorder. Returns to ON or OFF.

:RECOOrder[1|2|3|4]:GROUPs <value>

Description Sets the group number of channel recorder.

Example :RECOOrder2:GROUPs 100
 Sets the group number as 100 for channel recorder.

:RECOOrder[1|2|3|4]:GROUPs?

Description Queries the group number of channel recorder.

Example :RECOOrder2?
 Returns the group number of CH2 recorder.

:RECOOrder[1|2|3|4]:ENABLE {ON|OFF}

Description Sets the channel recorder ON or OFF.

Example :RECOOrder2:ENABLE ON
 Enables CH2 recorder.

:RECOOrder[1|2|3|4]:ENABLE?

Description Queries the state of channel recorder.

Example :RECOOrder2:ENABLE?
 Returns the state of CH2 recorder, ON or OFF.

:SEQUence[1|2]:CYCLEs {N|I}[,<value>]

Description Sets the cycle number of sequence.

Parameter {N | I} Sets cycle number as infinite (I) or specified value (N, <value>).

Example :SEQUence2:CYCLEs N,20
 Sets the cycle number of sequence as 20.

:SEQUence[1|2]:CYCLEs?

Description Queries the cycle number of the sequence.

Example :SEQUence2:CYCLEs?
 Queries the cycle number of the sequence.
 Returns to I or N, <value>.

:SEQUence[1|2]:ENDState {OFF|LAST}

Description Sets terminate state of sequence.

Parameter	OFF	Output disabled (OFF): instrument automatically disable output when output is complete.
	LAST	The last group (LAST): instrument stays at the output state of the last group when output is complete.

Example :SEQUence2:ENDState LAST
 Sets the terminate state of sequence as “the last group”.

:SEQUence[1|2]:ENDState?

Description Queries the terminate state of the sequence.

Example :SEQUence2:ENDState?
 Queries the CH2terminate state of the sequence.
 Returns to OFF or LAST.

:SEQUence[1|2]:GROUPs <value>

Description	Sets the output group number of sequence.	
Parameter	<value>	The definition of output group number is that the default voltage/current group number of power output from each cycle ranges from 1 to 2048. All group number of sequence = output group number*cycle number. Power will terminate timer function after completing outputs of all group numbers.
Example	:SEQUence2:GROUPs 25 Sets the CH2 output group number of sequence as 25.	

:SEQUence[1|2]:GROUPs?

Description	Queries the output group number of the sequence.	
Example	:SEQUence2:GROUPs? Queries the CH2 output group number of the sequence. Returns to an integer between 1 to 2048.	

:SEQUence[1|2]:PARAMeter<No>,<volt>,<curr>,<time>

Description	Sets the parameter of the specified group.	
Parameter	<No>	The serial number of sequence parameter of the specified group, integer, 0 to 2047.
	<volt>	The voltage of sequence parameter of the group. Unit is V, number, voltage range of the active channel.

	<curr>	The current of sequence parameter of the group. Unit is A, number, current range of the active channel.
	<time>	The time of sequence parameter of the group. Unit is s, number, 1s to 300s.
Example	:SEQUence2:PARAMeter 1,8,1,10 Sets the CH2 sequence parameter of the 1st group as 8V,1A,10s.	
:SEQUence[1 2]:PARAMeter? <No>,<count>		
Description	<p>Sets the sequence number for initial execution. Queries the specified several groups of sequence parameter.</p> <p>Returns to a string initiating from #. Data head is to describe data length information starting from #. For example, ##9000000037, the later 9 digits (000000037) following the initial 9 indicate length of data flow (37 bytes).</p> <p>The format of sequence parameter of each group is "serial number, voltage, current, timer time", and parameter of each group is divided by semicolon";". For example: 1,8.000,1.0000,10;2,6.000,1.0000,10; represents sequence parameters for 2 groups; the serial number of sequence parameter for 1st group is 1 with voltage 8.000V, current 1.0000A and timer time 10s. The serial number of sequence parameter for 2nd group is 2 with voltage 6.000V, current 1.0000A and timer time 10s.</p>	
Parameter	<No>	The serial number 0 ~ 2047 of the first group within the several sequence output parameters that are in need of query.
	<count>	Group number of sequence parameter in need of query. Integer, 1 to 2048.

Example :SEQUence2:PARAMeter? 1,2
 Queries 2 groups' sequence parameters from the 1st group for CH2.

:SEQUence[1|2]:STARt <value>

Description Sets the sequence number for initial execution.

Parameter <value> Integer 0 - 2047

Example :SEQUence2:STARt 10
 Sets the CH2 sequence output to start from the group 11.

:SEQUence[1|2]:STARt?

Description Queries the sequence number for initial execution of the channel sequence output.

Example :SEQUence2:STARt?
 Returns the initial sequence number of CH2 sequence output.

:SEQUence[1|2] [:STATe] {ON|OFF}

Description Enable or disable sequence function.
 Enabling the sequence will change state of channel output, make sure the changed output state will Not impact the device connected with power before enabling. Sequence output is activated only when both sequence and channel output are enabled. To modify parameter is Not available when sequence is being enabled. For multi-channel model, change the active channel and set parameter of selected channel. It is Not allowed to enable sequence and delay simultaneously.

Example :SEQUence2:STATe ON
 Enable sequence output for CH2.

:SEQUence[1|2] [:STATe]?

Description Queries the state of sequence output.

Example :SEQUence2:STATe?
 Queries the CH2 state of sequence output. Returns to ON or OFF.

:SEQUence[1|2]:TEMPlet:CONSTRuct

Description Sends the command. Instrument builds, based on the actively selected templet and set the sequence parameter.

:SEQUence[1|2]:TEMPlet:FALLRate <value>

Description Sets the falling degree of ExpFall.

Parameter <value> Integer from 0 to 10.

Example :SEQUence2:TEMPlet:FALLR 5
 Sets the CH2 falling degree of ExpFall as 5.

:SEQUence[1|2]:TEMPlet:FALLRate?

Description Queries the falling degree of the active ExpFall

Example :SEQUence2:TEMPlet:FALLRate?
 Queries the CH2 falling degree of the active ExpFall. Returns to an integer ranging from 0 to 10.

:SEQUence[1|2]:TEMPlet:INTERval <value>

Description	Sets the time interval.
Parameter	<value> Integer 1s to 300s Time interval is the duration period in accord with each time parameter of the active selected templet.
Example	:SEQUence2:TEMPlet:INTERval 15 Sets the CH2 time interval as 15s. Pulse templet does Not support this parameter.

:SEQUence[1|2]:TEMPlet:INTERval?

Description	Queries the active time interval.
Example	:SEQUence2:TEMPlet:INTERval? Queries the CH2 active time interval. Returns to an integer between 1 to 300.

:SEQUence[1|2]:TEMPlet:INVErt {ON|OFF}

Description	Enable or disable invert function of the active selected templet.
Parameter	When enabling the invert function, invert the target waveform in instrument first, and build timer parameter. Invert function is available for Sine, Pulse and Ramp templets only.
Example	:SEQUence2:TEMPlet:INVErt ON Enable the invert function of active selected templet for CH2.

:SEQUence[1|2]:TEMPlet:INVErt?

Description Queries whether the invert function under the active selected templet is enabled.

Example :SEQUence2:TEMPlet:INVErt?
Returns to the templet of CH2 to check if the invert function is ON or OFF.

:SEQUence[1|2]:TEMPlet:MAXValue{<value>|MINimum|MAXimum}

Description Sets the maximum voltage or current value of the active selected templet.

Parameter When voltage is the object to edit, it is the maximum voltage to be set. When current is the object to edit, it is the maximum current to be set. When templet type is Pulse, the command is to set high level value.

Example :SEQUence2:TEMPlet:MAXValue 5
Sets the CH2 maximum voltage of the active selected templet as 5V.

:SEQUence[1|2]:TEMPlet:MAXValue?

Description Queries the maximum voltage or current value of the active selected templet.

Example :SEQUence2:TEMPlet:MAXValue?
Queries the CH2 maximum voltage or current value of the active selected templet.

:SEQUence[1|2]:TEMPlet:MINValue{<value>|MINimum|MAXimum}

Description	Sets the minimum voltage or current value of the active selected templet.
Parameter	When voltage is the object to edit, it is the minimum voltage to be set. When current is the object to edit, it is the minimum current to be set. When templet type is Pulse, the command is to set high level value.
Example	:SEQUence2:TEMPlet:MINValue 0.5 Sets the CH2 minimum voltage of the active selected templet as 0.5V.

:SEQUence[1|2]:TEMPlet:MINValue?

Description	Queries the minimum voltage or current value of the active selected templet.
Example	:SEQUence2:TEMPlet:MINValue? Returns to the CH2 minimum voltage or current value of the active selected templet.

:SEQUence[1|2]:TEMPlet:OBject {V|C}

Description	Selects the object to be edited by the active templet.
Parameter	V C Selects the object to be edited as voltage V or current C.
Example	:SEQUence2:TEMPlet:OBject V Sets the CH2 voltage to be edited.

:SEQUence[1|2]:TEMPlet:OBject?

Description	Queries the object being edited of the active selected templet.
Example	:SEQUence2:TEMPlet:OBject? Returns to the object being edited of the actively selected templet for CH2.

:SEQUence[1|2]:TEMPlet:POINTs <value>

Description	Sets the overall points (adopts the group numbers of sequence parameter constructed by the actively selected templet, which Pulse type does Not support).
Parameter	<value> The overall points range from 10 to 2048.
Example	:SEQUence2:TEMPlet:POINTs 10 Sets the CH2 overall points as 10.

:SEQUence[1|2]:TEMPlet:POINTs?

Description	Queries the actively set overall points.
Example	:SEQUence2:TEMPlet: POINTs? Returns the CH2 actively set overall points.

:SEQUence[1|2]:TEMPlet:RISERate <value>

Description	Sets the rising degree of ExpRise.
Parameter	<value> Ranges from 0 to 10.
Example	:SEQUence2:TEMPlet:RISERate 10 Sets the rising degree of ExpRise as 10 for CH2.

:SEQUence[1|2]:TEMPlet:RISERate?

Description Queries the rising degree of the actively set ExpRise.

Example :SEQUence2:TEMPlet:RISERate?
Returns the rising degree of the actively set ExpRise for CH2.

**:SEQUence[1|2]:TEMPlet:SElect
{SINE|PULSE|RAMP|UP|DN|UPDN|RISE|FALL}**

Description Selects templet type.

Example :SEQUence2:TEMPlet:SElect SINE
Sets the selected templet type as SINE for CH2.

:SEQUence[1|2]:TEMPlet:SElect?

Description Queries the actively selected templet type.

Example :SEQUence2:TEMPlet:SElect?
Returns the actively selected templet type for CH2.

:SEQUence[1|2]:TEMPlet:SYMMetry <value>

Description Sets the symmetry of RAMP.

Parameter <value> Ranges from 0 to 100.

Example :SEQUence2:TEMPlet:SYMMetry 50
Sets the symmetry of RAMP as 50% for CH2.

:SEQUence[1|2]:TEMPlet:SYMMetry?

Description Queries the symmetry of the actively set RAMP.

Example :SEQUence2:TEMPlet:SYMMetry?
Returns the symmetry of the actively set RAMP for CH2.

:SEQUence[1|2]:TEMPlet:WIDTH <value>

Description Sets the pulse width of Pulse.

Parameter <value> The available setting range, which is from 1s to (period - 1s), is relevant to the actively set period.

Example :SEQUence2:TEMPlet:WIDTH 5
Sets the pulse width of Pulse as 5s for CH2.

:SEQUence[1|2]:TEMPlet:WIDTH?

Description Queries the pulse width of the actively set Pulse.

Example :SEQUence2:TEMPlet:WIDTH?
Returns the pulse width of the actively set Pulse for CH2.

:TRIGger:IN[:ENABLE] {D0|D1|D2|D3|D4},{ON|OFF}

Description Enables or disables the trigger input function of the specified data line.

Example :TRIGger:IN D0,ON
Enabled trigger input function of the D0 data line.

:TRIGger:IN[:ENABLE]?{D0|D1|D2|D3|D4}

Description	Queries the state of the trigger input function of the specified data line.
-------------	---

Example	:TRIGger:IN:? D0 Returns the state of the trigger input function of the D0 data line.
---------	--

:TRIGger:IN:RESPonse{D0|D1|D2|D3|D4},{ON|OFF|TOGGLE|POWER|CV|CC|CR|IND|SER|PAR }

Description	Sets the output response from the trigger input of the specified data line.
-------------	---

Parameter	ON OFF TOGGLE POWER CV CC CR IND SER PAR }
-----------	--

Enable output (ON): when the input signal of the specified data line meets the trigger condition, enable the channel output of the actively selected controlled channel.

Disable output (OFF): when the input signal of the specified data line meets the trigger condition, disable the channel output of the actively selected controlled channel.

Output Invert mode (TOGGLE): when input signal of the specified cable line meets the set triggering condition, invert the currently selected controlled channel output.

Output Power mode (POWER): when input signal of the specified cable line meets the set triggering condition, set the currently controlled channel in the power mode.

Output Load CV mode (CV): when input signal of the specified cable line meets the set triggering condition, set the currently controlled channel in

the load CV mode.

Output Load CC mode (CC): when input signal of the specified cable line meets the set triggering condition, set the currently controlled channel in the load CC mode.

Output Load CR mode (CR): when input signal of the specified cable line meets the set triggering condition, set the currently controlled channel in the load CR mode.

Output Individual mode (IND): when input signal of the specified cable line meets the set triggering condition, set CH1/CH2 in the individual power mode.

Output Series mode (SER): when input signal of the specified cable line meets the set triggering condition, set CH1/CH2 in the series power mode.

Output Parallel mode (PER): when input signal of the specified cable line meets the set triggering condition, set CH1/CH2 in the parallel power mode.

Example	:TRIGger:IN:RESPonse D0,ON Sets the output response from the trigger input of the D0 data line as ON.
Note	IND SER PAR takes CH1/CH2 as the main body, so it needs to run before executing this parameter: TRIGger:IN:SOURce Dx, CH1, ON and TRIGger:IN:SOURce Dx, CH2, ON.

:TRIGger:IN:RESPonse? {D0|D1|D2|D3|D4}

Description	Queries the output response from the trigger input of the specified data line
-------------	---

Example :TRIGger:IN:RESPonse? D0
Returns the output reponse of the trigger input of the queried D0 data line.

:TRIGger:IN:SENSitivity
{D0|D1|D2|D3|D4},{LOW|MID|HIGH}

Description Sets the trigger sensitivity from the trigger input of the specified data line.

Parameter	LOW	Selecting lower level in trigger
	MID	sensitivity will avoid false press in
	HIGH	Noisy environment.

Example :TRIGger:IN:SENSitivity D0,LOW
Sets the trigger sensitivity from the trigger input of D0 data line as LOW.

:TRIGger:IN:SENSitivity?{D0|D1|D2|D3|D4}

Description Queries the trigger sensitivity from the trigger input of the specified data line.

Example :TRIGger:IN:SENSitivity?D0
Returns the trigger sensitivity from the trigger input of D0 data line.

:TRIGger:IN:SOURce {D0|D1|D2|D3|D4} ,
{CH1|CH2|CH3|CH4},{ON|OFF}

Description Sets the controlled channel from the trigger input of the specified data line.

Parameter	CH1	Any of the channels, CH1, CH2, CH3, CH4 is available for controlled channel.
	CH2	
	CH3	
	CH4	

Example :TRIGger:IN:SOURce D0,CH1,ON
Sets the controlled channel from the trigger input of D0 data line as CH1.

:TRIGger:IN:SOURce?{D0|D1|D2|D3|D4}

Description Queries the controlled channel from the trigger input of the specified data line.

Example :TRIGger:IN:SOURce? D0
Returns the controlled channel from the trigger input of D0 data line.

:TRIGger:IN:TYPE
{D0|D1|D2|D3|D4},{RISE|FALL|HIGH|LOW|STATE }

Description Sets the trigger type from the trigger input of the specified data line.

Parameter	RISE FALL HIGH LOW STATE	Trigger from the following options of signal input: rising edge (RISE), falling edge (FALL), high level (HIGH), low level (LOW) or STATE. For the signal input, high level: 2.5V~3.3V, low level: 0V~0.8V, noise tolerance: 0.4V.
-----------	--------------------------------------	--

Example :TRIGger:IN:TYPE D0,RISE
Sets the trigger type from the trigger input of D0 data line as RISE.

:TRIGger:IN:TYPE?{D0|D1|D2|D3|D4}

Description Queries the trigger type from the trigger input of the specified data line.

Example :TRIGger:IN:TYPE? D0
Returns the trigger type from the trigger input of D0 data line.

:TRIGger:OUT:CONDition

{D0|D1|D2|D3|D4}, {OUTOFF|OUTON|>V|<V|=V|>C|<C|
=C|>P|<P|=P|AUTO}, <value>

Description	Sets the trigger condition from the trigger output of the specified data line.
-------------	--

Parameter	OUTOFF OUTON >V <V =V >C <C =C >P <P =P AUTO
-----------	--

When OUTOFF, OUTON or AUTO is selected, parameter <value> will be omitted.

Input trigger: disable output (OUTOFF) and enable output (OUTON), both of which indicate to disable or enable respectively the trigger when the specified controlled channel output.

Voltage trigger: greater than voltage (>V), less than voltage (<V), equal to voltage (=V), all of which indicate that when the output voltage of the specified controlled channel meets the set trigger condition, it will trigger then.

Current trigger: greater than current (>C), less than current (<C), equal to current (=C), all of which indicate that when the output current of the specified controlled channel meets the set trigger condition, it will trigger then.

Power trigger: greater than power (>P), less than power (<P), equal to power (=P), all of which indicate that when the output power of the specified controlled channel meets the set trigger condition, it will trigger then.

Automatic trigger: instrument automatically triggers after enabling this function.

When either one of the following modes: voltage trigger (>V, <V, =V), current trigger (>C, <C, =C),

power trigger (>P, <P, =P) is selected, it is required to set parameter <value> (the specified voltage, current or power value of the trigger condition).

Example :TRIGger:OUT:CONDition D0,>V,10
Sets the trigger condition from the trigger output of D0 data line as output voltage>10V.

:TRIGger:OUT:CONDition? {D0|D1|D2|D3|D4}

Description Queries the trigger condition from the trigger output of the specified data line.

Example :TRIGger:OUT:CONDition? D0
Returns the trigger condition from the trigger output of D0 data line.

:TRIGger:OUT[:ENABle] {D0|D1|D2|D3|D4},{ON|OFF}

Description Enables or disables the trigger output function of the specified data line.

Parameter After enabling trigger output function, the specified data line will, when the output signal of the specified controlled channel meets the set trigger condition, output the specified level or square wave based on the setting of output signal.

Example :TRIGger:OUT D0,ON
Enables the trigger output function of D0 data line.

:TRIGger:OUT[:ENABLE]? {D0|D1|D2|D3|D4}

Description Queries the state of the trigger output function of the specified data line.

Example :TRIGger:OUT? D0
Returns the state of the trigger output function of D0 data line.

:TRIGger:OUT:POLARity {D0|D1|D2|D3|D4}, {POSITIVE|NEGATIVE}

Description Sets the polarity of the output signal from the trigger output of the specified data line.

Parameter	POSITIVE	Positive polarity (POSITIVE): when trigger condition is met, it will output the actively specified output signal.
------------------	-----------------	---

	NEGATIVE	Negative polarity (NEGATIVE) when trigger condition is met, it will invert and then output the actively specified output signal.
--	-----------------	--

Example :TRIGger:OUT:POLARity D0,POSITIVE
Sets the polarity of the output signal from the trigger input of D0 data line as POSITIVE.

:TRIGger:OUT:POLARity? {D0|D1|D2|D3|D4}

Description Queries the polarity of the output signal from the trigger input of the specified data line.

Example :TRIGger:OUT:POLARity? D0
Returns the polarity of the output signal from the trigger input of D0 data line.

:TRIGger:OUT:SOURce
{D0|D1|D2|D3|D4},{CH1|CH2|CH3|CH4}

Description	Sets the controlled channel from the trigger output of the specified data line.	
Parameter	CH1 CH2 CH3 CH4	Any of the channels, CH1, CH2, CH3, CH4 is available for selection as controlled channel of trigger output.
Example	:TRIGger:OUT:SOURce D0,CH1 Sets the controlled channel from the trigger output of D0 data line as CH1.	

:TRIGger:OUT:SOURce?{D0|D1|D2|D3|D4}

Description	Queries the controlled channel (channel) from the trigger output of the specified data line.	
Example	:TRIGger:OUT:SOURce? D0 Returns the controlled channel from the trigger output of D0 data line.	

Status Commands

STATUS?	158
:STATus:PRESet	159
:STATus:OPERation[:EVENT]?	159
:STATus:OPERation:CONDition?	159
:STATus:OPERation:ENABle <NRf>	159
:STATus:OPERation:ENABle?	160
:STATus:MEASurement[:EVENT]?	160
:STATus:MEASurement:ENABle <NRf>	160
:STATus:MEASurement:ENABle?	161
:STATus:MEASurement:CONDition?	161
:STATus:QUESTionable[:EVENT]?	161
:STATus:QUESTionable:CONDition?	161
:STATus:QUESTionable:ENABle <NRf>	162
:STATus:QUESTionable:ENABle?	162
:STATus:QUEEue[:NEXT]?	162
:STATus:QUEEue:ENABle <list>	162
:STATus:QUEEue:ENABle?	163
:STATus:QUEEue:DISable <list>	163
:STATus:QUEEue:DISable?	164
:STATus:QUEEue:CLEar	164

STATUS?

Description Returns the Status. 8 bits in the following format

Return Parameter 8 bits in the following format

	Bit	Item	Description
	0	CH1	0 = CC mode, 1 = CV mode
	1	CH2	0 = CC mode, 1 = CV mode
	2, 3	Tracking	01 = Independent, 11 = Tracking series, 10 = Tracking parallel
	4	Beep	0 = Off, 1 = On
	5	Output	0 = Off, 1 = On

	6, 7 Baud	00 = 115200bps, 01 = 57600bps, 10 = 9600bps
Example	STATUS?	

:STATus:PRESet

Description Clears the operation event enable registers, the measurement event enable registers and the questionable event register, The unit will then return to the default settings status.

Example :STATus:PRESet

:STATus:OPERation[:EVENT]?

Description Read the operation event register.

Example :STATus:OPERation?
Reads the operation event register.

:STATus:OPERation:CONDition?

Description Read the operation condition status register.

Example :STATus:OPERation:CONDition?
Read the contents of the operation condition status register.

:STATus:OPERation:ENABLE <NRf>

Description Programs the operation enable status register.

Parameter < NRf> 8: CL (Current enable bit).
16: CLT (Current limit tripped enable bit).
64: PSS (Power supply shutdown enable bit).

Example :STATus:OPERation:ENABLE 64
 Enable the power supply shutdown bit.

:STATus:OPERation:ENABLE?

Description Read the operation enable status register.

Example :STATus:OPERation:ENABLE?
 Read the contents of the operation enable status register.

:STATus:MEASurement[:EVENT]?

Description Reads the measurement event status register.

Example :STATus:MEASurement?
 Reads the contents of the measurement event status register.

:STATus:MEASurement:ENABLE <NRf>

Description Program the measurement enable status register.

Parameter < NRf> 8: ROF (reading overflow enable bit).
 16: PTT (pulse trigger timeout enable bit).
 32: RAV (Reading available enable bit).
 512: Buffer full enable bit. The register is 16 bits. If <value> is between 512 and 1,023, it is certainly valid. If <value> is between 1,024 and 65,535, ensure Cal (bit8) is a valid value for it to work.

Example :STATus:MEASurement:ENABLE 8
 Enables the ROF bit.

:STATus:MEASurement:ENABle?

Description Read the measurement enable status register.

Example :STATus:MEASurement:ENABle?
 Read the contents of the measurement enable status register.

:STATus:MEASurement:CONDition?

Description Read the measurement condition status register.

Example :STATus:MEASurement:CONDition?
 Read the contents of the measurement condition status register.

:STATus:QUEStionable[:EVENT]?

Description Read the questionable event status register.

Example :STATus:QUEStionable?
 Read the questionable event status register.

:STATus:QUEStionable:CONDition?

Description Read the questionable condition status register.

Example :STATus:QUEStionable:CONDition?
 Read the questionable condition status register.

:STATus:QUEStionable:ENABle <NRf>

Description	Programs the questionable enable status register.	
Parameter	< NRf>	256: CAL (Calibration summary enable bit). Register is 16 bits. If <value> is between 256 and 511, it is certainly valid. If <value> is between 512 and 65,535, ensure Cal (bit8) is a valid value.
Example	:STATus:QUEStionable:ENABle 256 Sets the CAL bit.	

:STATus:QUEStionable:ENABle?

Description	Read the questionable enable status register.	
Example	:STATus:QUEStionable:ENABle? Read the contents of the questionable enable status register.	

:STATus:QUEue[:NEXT]?

Description	Read the next message in the error queue.	
Example	:STATus:QUEue? Read the next error message.	

:STATus:QUEue:ENABle <list>

Description	Specifies which error and status messages get enabled for the error queue.	
Parameter	<list>	(-440:+900): Full range error messages. (-110): Single error message. (-110:-222): A specific range of error messages.

(-110:-222, -220): A specific range of error messages and a single error message (separated by a comma).

Example :STaTus:QUeue:ENABle (-110:-222)
 Enables error messages that are between error message -100 and -222.

:STaTus:QUeue:ENABle?

Description Read the error and status messages that have been enabled.

Example :STaTus:QUeue:ENABle?
 Returns the contents of the enabled error and status messages.

:STaTus:QUeue:DISABle <list>

Description Specifies which messages will not be placed in the error queue.

Parameter <list>
 (-440:+900): Full range error messages.
 (-110): Single error message.
 (-110:-222): A specific range of error messages.
 (-110:-222, -220): A specific range of error messages and a single error message (separated by a comma).

Example :STaTus:QUeue:DISABle (-110:-222)
 The error messages in the range of -110 to -222 will not appear in the error queue.

:STATus:QUEue:DISable?

Description Reads the disabled messages.

Example :STATus:QUEue:DISable?
Returns the disabled messages.

:STATus:QUEue:CLEar

Description Empty all the messages from the error queue.

Example :STATus:QUEue:CLEar
Empty all the messages from the error queue.

System Commands

:SYSTem:VERSion?	166
:SYSTem:ERRor?	166
:SYSTem:ERR?	166
:SYSTem:CLEar	167
:SYSTem:POSetup <name>	167
:SYSTem:POSetup?	167
:SYSTem:COMMunicate:LAN:DHCP[:STATe] 	167
:SYSTem:COMMunicate:LAN:DHCP[:STATe]?	168
:SYSTem:COMMunicate:LAN:IPADdress	
<IPaddress>	168
:SYSTem:COMMunicate:LAN:IPADdress?	168
:SYSTem:COMMunicate:LAN:SMASk<mask>	169
:SYSTem:COMMunicate:LAN:SMASk?.....	169
:SYSTem:COMMunicate:LAN:GATEway	
<IPaddress>	169
:SYSTem:COMMunicate:LAN:GATEway?	170
:SYSTem:COMMunicate:LAN:MANualip	
[:STATe]	170
:SYSTem:COMMunicate:LAN:MANualip[:STATe]? 170	
:SYSTem:COMMunicate:LAN:APPLY.....	170
:SYSTem:REMote.....	171
REMote	171
:SYSTem:BEEPer:STATe	171
BEEP<Boolean>	171
:SYSTem:BEEPer:STATe?	172
:SYSTem:LOCal.....	172
LOCal	172
:SYSTem:INTerface [USB RS232 GPIB LAN]	172
:SYSTem:LANGuage [CHINese ENGLISH].....	172
:SYSTem:LANGuage?	173
:SYSTem:BAUDrate:USB[9600 19200 38400	
57600 115200].....	173
:SYSTem:BAUDrate:USB?	173
BAUD<NR1>.....	173
HELP?.....	174

:SYSTem:VERSion?

Description Query the SCPI version.

Example :SYSTem:VERSion?
 Query the SCPI version.

:SYSTem:ERRor?

Description Read and clear the last error and from the error queue.

Example :SYSTem:ERRor?
 Read and clear the last error and from the error queue.

:SYSTem:ERR?

Description Checks the error status and returns the last error message

Example :SYSTem:ERRor?
 Read and clear the last error and from the error queue.

Message contents	Descriptions
a program mnemonic too long	The command length must be 15 characters or less.
b Invalid character	Invalid characters, such as symbols, are entered. Example: VOUT#
c Missing parameter	The parameter is missing from the command. Example: VEST: (should have a number)
d Data out of range	The entered valude exceeds the specification. Example: VSET: 33 (should be ≤ 32V)

E Command not allowed	The entered command is not allowed in the circumstance. Example: trying to set CH2 output while in the tracking mode.
f Undefined header	The entered command does not exist, or the syntax is wrong.

:SYSTem:CLEar

Description	Clear the error messages.
Example	:SYSTem:POSetup RST Clears the error queue.

:SYSTem:POSetup <name>

Description	Set the power on configuration.
Parameter	<name> RST: Machine default settings. Last: Machine last settings.
Example	:SYSTem:POSetup RST Set the power on configuration to RST.

:SYSTem:POSetup?

Description	Query the power on configuration.
Example	:SYSTem:POSetup? Query the power on configuration.

**:SYSTem:COMMunicate:LAN:DHCP[:STATe] **

Description	Sets the DHCP state on or off.
Parameter	 0/OFF: DHCP off 1/ON:DHCP on

Note	The :SYSTem:COMMunicate:LAN:APPLY command must be executed before the DHCP settings can take effect.
------	--

Example	:SYSTem:COMMunicate:LAN:DHCP ON Enable DHCP
---------	--

:SYSTem:COMMunicate:LAN:DHCP[:STATe]?

Description	Query the DHCP status.
-------------	------------------------

Example	:SYSTem:COMMunicate:LAN:DHCP? Query the DHCP state.
---------	--

:SYSTem:COMMunicate:LAN:IPADdress <IPAddress>

Description	Sets the IP address.
-------------	----------------------

Parameter	<IP address> ASCII string, within the range of 1.0.0.0 to 223.255.255.255 (excluding 127.nnn.nnn.nnn).
-----------	--

Note	This command is only applicable for the manual IP mode. The SYSTem:COMMunicate:LAN:APPLY command needs to be executed before the IP address settings can take effect.
------	---

Example	:SYSTem:COMMunicate:LAN:IPADdress Sets the IP address to 172.131.161.152.
---------	--

:SYSTem:COMMunicate:LAN:IPADdress?

Description	Queries the IP address.
-------------	-------------------------

Example	:SYSTem:COMMunicate:LAN:IPADdress? Queries the IP address.
---------	---

:SYSTem:COMMunicate:LAN:SMASk<mask>

Description	Sets the subnet mask.	
Parameter	<mask>	ASCII string, within the range of 1.0.0.0 to 255.255.255.255.
Note	The SYSTem:COMMunicate:LAN:APPLy command needs to be executed before the subnet mask setting can take effect.	
Example	:SYSTem:COMM:LAN:SMAS 255.255.255.0 Sets the subnet mask to 255.255.255.0.	

:SYSTem:COMMunicate:LAN:SMASk?

Description	Query the subnet mask.	
Example	:SYSTem:COMMunicate:LAN:SMASk? Query the subnet mask.	

:SYSTem:COMMunicate:LAN:GATEway <IPaddress>

Description	Sets the gateway IP address.	
Parameter	<IP address>	ASCII string, within the range of 1.0.0.0 to 223.255.255.255 (excluding 127.nnn.nnn.nnn).
Note	The SYSTem:COMMunicate:LAN:APPLy command needs to be executed before the gateway IP address setting can take effect.	
Example	:SYSTem:COMMunicate:LAN:GATEway 172.16.3.1 Sets the gateway IP to 172.16.3.1.	

:SYSTem:COMMunicate:LAN:GATEway?

Description	Queries the gateway IP.
Example	:SYSTem:COMMunicate:LAN:GATEway? Queries the gateway IP.

**:SYSTem:COMMunicate:LAN:MANualip[:STATe] **

Description	Allow the IP address to be set manually.
Parameter	< b > 0/OFF: disable the manual IP address. 1/ON: enable the manual IP address.
Note	The SYSTem:COMMunicate:LAN:APPLy command needs to be executed before the subnet mask setting can take effect.
Example	:SYSTem:COMMunicate:LAN:MANualip ON Enables a manual IP address to be set.

:SYSTem:COMMunicate:LAN:MANualip[:STATe]?

Description	Queries whether manual IP addressing has been enabled or disabled.
Example	:SYSTem:COMMunicate:LAN:MANualip? Queries the status of the manual IP addressing.

:SYSTem:COMMunicate:LAN:APPLy

Description	When this command is executed, all the LAN settings are applied.
Example	:SYSTem:COMMunicate:LAN:APPLy Applies all the LAN settings.

:SYSTem:REMote

Description Sets the unit to remote control.

Example :SYSTem:REMote
Sets to remote control mode.

REMote

Description Sets the unit to remote control.

Example REMote
Sets to remote control mode.

**:SYSTem:BEEPer:STATe **

Description Turn the buzzer on or off.

Parameter < b > 0/OFF: Turn the buzzer off.
1/ON: Turn the buzzer on.

Example :SYSTem:BEEPer:STATe OFF
Turns the buzzer off.

BEEP<Boolean>

Description Turn the buzzer on or off.

Parameter < Boolean > 0/OFF
1/ON

Example BEEP1
Turns on the beep

:SYSTem:BEEPer:STATe?

Description	Queries the buzzer status.
-------------	----------------------------

Example	:SYSTem:BEEPer:STATe? Queries the buzzer status.
---------	---

:SYSTem:LOCAl

Description	Disable remote control mode.
-------------	------------------------------

Example	:SYSTem:LOCAl Disables remote control mode.
---------	--

LOCAl

Description	Exits remote mode and sets the instrument to local mode.
-------------	--

Example	LOCAl
---------	-------

:SYSTem:INTerface [USB|RS232|GPIB|LAN]

Description	Sets the interface type
-------------	-------------------------

Example	:SYSTem:INTerface USB Sets the interface type to USB
---------	---

:SYSTem:LANGUage [CHINese|ENGLISH]

Description	Sets the system language
-------------	--------------------------

Example	:SYSTem:LANGUage ENGLISH Sets the system language to English
---------	---

:SYSTem:LANGUage?

Description Query the syetem lanuage.

Example :SYSTem:LANGUage?

:SYSTem:BAUDrate:USB[9600|19200|38400|57600|115200]

Description Sets the USB baud rate.

Example :SYSTem:BAUDrate:USB 9600

 Sets the USB baud rate to 9600.

:SYSTem:BAUDrate:USB?

Description Query the USB baud rate.

Example :SYSTem:BAUDrate:USB?

:SYSTem:BAUDrate:RS232[9600|19200|38400|57600|115200]

Description Sets the RS232 baud rate.

Example :SYSTem:BAUDrate:RS232 9600

 Sets the RS232 baud rate to 9600.

:SYSTem:BAUDrate:RS232?

Description Query the RS232 baud rate.

Example :SYSTem:BAUDrate:RS232?

BAUD<NR1>

Description Sets the baud rate to 9600/ 57600/ 115200.

Parameter <NR1> 0: 115200bps

 1: 57600bps

	2: 9600bps
Example	BAUD0 Sets the baud rate to 115200bps
Note	Default baud rate is 9600bps

HELP?

Description	Shows the Simple command list.	
Return Parameter	ISET<x>:<NR2>	Sets the value of current.
	VSET<x>:<NR2>	Sets the value of voltage.
	ISET<x>?	Return the value of current.
	VSET<x>?	Return the value of voltage.
	IOUT<x>?	Returns actual output current.
	VOUT<x>?	Returns actual output voltage.
	TRACK<NR1>	Sets the output of the power supply working on independent or tracking mode.
	BAUD<NR1>	Set the value of baud rate.
	RCL<NR1>	Recall the setting data from the memory which previous saved.
	SAV<NR1>	Saves the setting data to memory.
	BEEP<Boolean>	Sets the BEEP state on or off.
	OUT<Boolean>	Sets the output state on or off.
	LOCAL	Return to local mode
	REMOTE	Return to remote mode
	*IDN?	Returns instrument identification.
	ERR?	Returns instrument error messages.
	STATUS?	Returns the power supply state.

System Related Commands

*IDN?	175
*RST	175
*SAV<NRf>	176
SAV<NR1>	176
*RCL<NRf>	176
RCL <NR1>	176

*IDN?

Description	Read the instrument identification <string>.
Parameter	<string> The return string contains four fields, each separated by a comma. The first field is the manufacturer, followed by the model name, serial number and the version number.
Example	<p>*IDN?</p> <p>Returns the T3PSX3200P series identification: TELEDYNE,T3PS33203P,XXXXXXXXXX,V1.00 TELEDYNE: Manufacturer, T3PS33203P: Model name, XXXXXXXXXXXX: Serial number, V1.00: version number.</p>

*RST

Description	Resets the unit to RST default conditions.
Example	<p>*RST</p> <p>Resets the unit.</p>

***SAV<NRf>**

Description	Save the current setup to the selected save location.
Parameter	<NRf> 0 - 9, Corresponding to STATE00-STATE09
Example	*SAV 1 Stores the setting in memory 1(STATE01).

SAV<NR1>

Description	Save the current setup to the selected save location.
Parameter	<NR1> 0-9, Corresponding to STATE00-STATE09
Example	SAV 1 Stores the setting in memory 1(STATE01).

***RCL<NRf>**

Description	Recall the selected save setting from memory.
Parameter	<NRf> 0 - 9, Corresponding to STATE00-STATE09
Example	*RCL 2 Recalls the setting stored in memory 2(STATE02)

RCL <NR1>

Description	Save the current setup to the selected save location.
Parameter	<NR1> 0-9, Corresponding to STATE00-STATE09

Example

*SAV 1

Recalls the setting stored in memory 2(STATE02)

SCPI Status Registers SCPI

The SCPI instrument configuration is controlled by the status registers. The Status system records various instrument conditions into three main register groups: The status byte register, the standard event register group and the questionable data register group. The status byte register records a high-level summary of the other register groups. The following diagram is the SCPI Status System diagram.

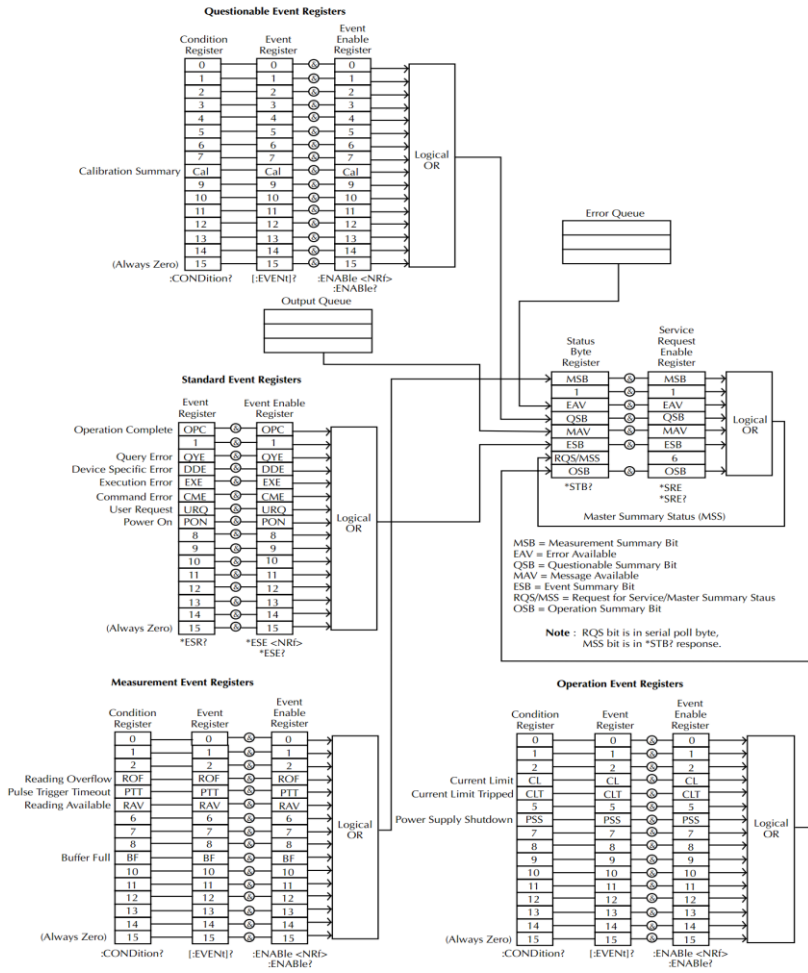

Note

URQ indicates that the "Lock" key on the panel has been used. (Entering lock from unlock or Entering unlock from lock).

Event Registers

The operation, measurement and questionable status register groups all have event registers. The event registers are read only registers that reflect the status of the unit. Individual bits in the event registers are latched (set) when a corresponding event occurs and will remain latched even if the corresponding event changes, as long as the event bit is still set. The register query (*ESR) or the command (*CLS) will automatically clear any set bits in the event registers. The reset command (*RST) will not clear the bits in the event register. Queries for the event registers will return a binary-weighted decimal value that represents the state of all the bits in an event register.

Enable Registers

The enable registers define which bits in the corresponding event register can be latched (set). The enable register can be read and written to. Any queries for the enable register will not clear the value in the register. The *CLS command will not clear the enable register, but will clear the events in the event register. To allow the individual bits in the event registers to be set, the corresponding bits in the enable registers must be set, where each bit is represented by a binary number.

Status Byte Register

The status byte register reports the status of the other status registers. The message available bit (bit 4), will indicate when there is a message in the output buffer. Clearing an event register will clear the corresponding bit in the status byte condition register. Reading all the data in the output buffer will clear the message available bit. To set the enable register mask for the status byte register and to generate an SRQ (service request) you must use the *SRE command to write the appropriate decimal value to the register.

Bit Definition for the Status Byte Register

Bit number	Decimal Value	Definition
0 Not used	1	Not used, returns "0"
1 Not used	2	Not used, returns "0"
2 Error Queue	4	Indicates that one or more errors are stored in the error queue.
3 Questionable Summary bit	8	One or more bits are set in the questionable data register (for enabled events).
4 Message Available bit	16	Indicates that a message is available in the output queue.
5 Standard Event Summary bit	32	Indicates that one or more bits are set in the standard event register. (For enabled events).
6 Master Summary bit	64	Indicates that a summary bit is set in the status byte register. (for enabled summary bits)
7 Unused	128	Not used, returns "0"

The status byte condition register is cleared when one of the following occurs:

- *CLS command is used to clear the status byte register.
- You read the event register from another register group (only clear the corresponding bit in the condition register)

The status byte enable register is cleared when the following occurs:

- When the *SRE 0 is command is executed.

Use the *STB? query to read the status byte register.

The *STB? query will return the contents of the status byte register as long as the bit 6 (MSS) has been cleared.

Using the *OPC? query to place a signal in the output buffer.

In general it is best to use the Operation Complete Bit (bit 0) in the standard event register to check to see if an operation/command has completed. After executing the *OPC command, the OPC bit will be set to 1. If a command or query is placed in the output buffer immediately before the *OPC command is sent, the Operation Complete Bit can be used to determine when the information can be used. However if too many commands/queries are executed prior to the execution of the *OPC command, the output buffer could become saturated and the unit will stop taking readings.

Standard Event Register

The Standard Event Register reports the following types or events: Power on has been detected, command syntax errors, command execution errors, self test and execution errors, query errors or if the *OPC command is executed. Any one or more of these events will set the standard event summary bit in the status byte register. To set a mask for the enable register, a binary-weighted decimal number must be written using the *ESE command.

Bit Definition for the Standard Event Register

Bit number	Decimal Value	Definition
0 Operation Complete Bit	1	The *OPC command will set this bit when all overlapping operations have completed (including the *OPC command itself).
1 Not used	2	Not used, returns "0"
2 Query Error	4	The instrument tried to read the error queue when the queue was empty or the queue was read before a new command was given or the input/output buffers are full.
3 Device Error	8	A self-test, calibration or other device-specific error.
4 Execution Error	16	An execution error.
5 Command Error	32	A command syntax error.
6 Not used	64	Not used, return 0.
7 Power on	128	This bit is set if the power supply has been reset from the last time you read the event register.

The following will clear the standard event register:

- The *CLS command is executed.
- The *ESR? command is used to query the event register.

The following will clear the standard event enable register.

- The *ESE command is executed.

Status Byte Register Commands

*SRE <Allowed values>	184
*SRE?	184
*STB?	184

*SRE <Allowed values>

Description Service request enable register (SRER) command that writes a binary weighed value which determines which events in the status byte register are enabled.

Parameter Allowed values Decimal vales: 0~255

Example *SRE 7
Returns the SRER setting (0000 0111)

*SRE?

Description Queries the status byte enable register. This command returns a binary-weighted decimal number that indicates which bits are set in the status byte register. The range is from 0~255.

Example *SRE?
Returns "7", which are the contents of the service request enable register.

*STB?

Description Query the status byte register. This is the same as performing a serial poll, however the master summary bit (MSS, bit 6) will not be cleared by the *STB command. The return value range is from 0 to 255.

Example

*STB?

Returns 81 if the status byte register is set to 01010001.

Status Event Register Commands

*ESE <Allowed Values>.....	186
*ESE?.....	186
*ESR?	186

*ESE <Allowed Values>

Description	Sets the standard event enable register. The allowable value range is 0~255.
-------------	--

Example	*ESE 65 Sets the ESER as 0100 0001.
---------	--

*ESE?

Description	Queries the standard event enable register. It returns a binary-weighted decimal value representing all the enabled bits in the standard event register.
-------------	--

Example	*ESE? Returns 65, as the ESER is set as 0100 0001.
---------	---

*ESR?

Description	Queries the standard event register. It returns a binary-weighted decimal value in the range of 0~255.
-------------	--

Example	*ESR? It returns 198, as the ESER is set as 0100 0001.
---------	---

Other Status Register Commands

*CLS	187
*OPC	187
*OPC?	187

*CLS

Description	Clears the status byte summary registers and the all event registers.
-------------	---

Example	*CLS Clears all the event registers, which include Standard event registers, Operation event registers, Measurement event registers, Questionable event registers.
---------	---

*OPC

Description	After all the pending operations are complete, sets the operation complete bit in the standard event status register.
-------------	---

Example	*OPC
---------	------

*OPC?

Description	Will return "1" to the output queue when all pending operations have been completed.
-------------	--

Example	*OPC? After the last command is executed, will return a "1" to the output queue.
---------	---

Errors

Error Message ---

- Errors are stored in a first in-first out (FIFO) order. The first error message that is returned is the first error message that was stored. When an error is read it is also cleared from the queue.
- If there are more than 10 errors produced the last error in the queue is replaced with "Que overflow". Unless the error queue is cleared, no more errors can be written to the error queue. If there are no errors in the error queue, the instrument will return "No error".
- To clear the error queue, you can use the :SYSTem:CLEar command or cycle the power. When you read a message from the error queue that message will be cleared from the error queue. Using the *RST command to reset the instrument does not clear the error queue.
- Remote control instructions can be used to clear the error queue. See the instructions listed in the previous chapter for details.

Command Errors

- 440 Query unterminated after indefinite
- 430 Response
- 420 Query deadlocked
- 410 Query unterminated
- 363 Query interrupted
- 350 Input buffer overrun
- 330 Queue overflow
- 314 Self-test failed
- 315 Save/recall memory lost
- 260 Configuration memory lost
- 241 Expression error
- 230 Hardware missing
- 225 Data corrupt or stale
- 224 Out of memory
- 223 Illegal parameter value
- 222 Too much data
- 221 Parameter data out of range
- 220 Settings conflict
- 200 Parameter error
- 178 Execution error
- 171 Expression data not allowed
- 170 Invalid expression
- 161 Expression error
- 160 Invalid block data
- 158 Block data error
- 154 String data not allowed
- 151 String too long

- 150 Invalid string data String data error
- 148 Character data not allowed
- 144 Character data too long
- 141 Invalid character data
- 140 Character data error
- 124 Too many digits
- 123 Exponent too large
- 121 Invalid character in number
- 120 Numeric data error
- 114 Header suffix out of range
- 113 Undefined header
- 112 Program mnemonic too long
- 111 Header separator error
- 110 Command header error
- 109 Missing parameter
- 108 Parameter not allowed
- 105 GET not allowed
- 104 Data type error
- 103 Invalid separator
- 102 Syntax error
- 101 Invalid character
- 100 Command error
- +000 No error
- +101 Operation complete
- +301 Reading overflow
- +302 Pulse trigger detection timeout
- +306 Reading available
- +310 Buffer full

- +320 Current limit event
- +321 Current limit tripped event
- +409 OTP Error
- +410 OVP Error
- +438 Date of calibration not set
- +440 Gain-aperture correction error
- +500 Calibration data invalid
- +510 Reading buffer data lost
- +511 GPIB address lost
- +512 Power-on state lost
- +514 DC Calibration data lost
- +515 Calibration dates lost
- +522 GPIB communication data lost
- +610 Questionable calibration
- +900 Internal system error

APPENDIX

Replacing the Fuse

- Steps
1. Remove the power cord and then take out the box using a small screw driver.

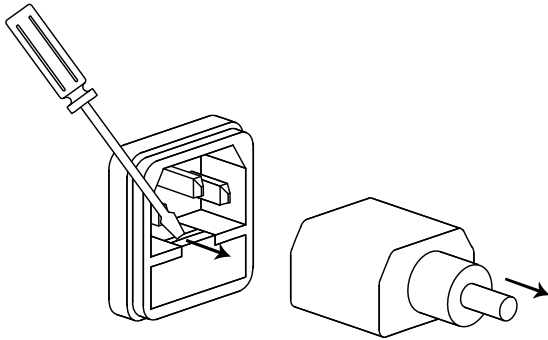

2. The fuse is stored in the housing.

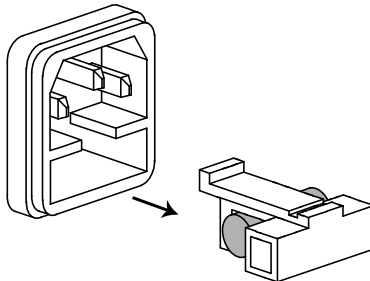

-
- Rating
- T3.15A/250V (220V/230V)
 - T6.30A/250V (100V/120V)

Specifications

The specifications apply under the following conditions: The T3PSX3200P series is powered on for at least 30 minutes, within +20°C-+30°C.

Power Mode

Output Rating	CH1/CH2 Independent	0 - 32.000V, 0 - 3.0000A (T3PS13206: 0 - 6.0000A)
	CH1, CH2 Series	0 - 64.000V, 0 - 3.0000A
	CH1, CH2 Parallel	0 - 32.000V, 0 - 6.0000A
	CH3	0 - 5.000V, 0 - 1.0000A (for T3PS43203P)
	CH4	0 - 15.000V, 0 - 1.0000A (for T3PS43203P)
Voltage	Line regulation	$\leq 0.01\% + 3\text{mV}$
	Load regulation	$\leq 0.01\% + 3\text{mV}$ (rating current $\leq 3\text{A}$) $\leq 0.02\% + 5\text{mV}$ (rating current $> 3\text{A}$)
	Ripple & noise (5Hz-1MHz)	$\leq 0.35\text{mVrms}$, $\leq 0.5\text{mVrms}$ (T3PS13206) $\leq 1\text{mVrms}$ (T3PS43203P:CH3/CH4)
	Transient recovery time	$\leq 50\mu\text{s}$, (T3PS13206: $\leq 100\mu\text{s}$) (50% load change, minimum load 0.5A)
	Temperature coefficient	$\leq 300\text{ppm}/^\circ\text{C}$
Current	Line Regulation	$\leq 0.2\% + 3\text{mA}$
	Load Regulation	$\leq 0.2\% + 3\text{mA}$
	Ripple & noise	$\leq 2\text{mArms}$ $\leq 4\text{mArms}$ (T3PS13206)
Tracking Operation	Tracking error	$\leq 0.1\% + 10\text{mV}$ of Master (0 - 32V) (No Load, with load add load regulation $\leq 100\text{mV}$)

	Parallel regulation	Line: $\leq 0.01\% + 3\text{mV}$ Load: $\leq 0.01\% + 3\text{mV}$ (rating current $\leq 3\text{A}$) $\leq 0.02\% + 5\text{mV}$ (rating current $> 3\text{A}$)
	Series regulation	Line: $\leq 0.01\% + 5\text{mV}$ Load: $\leq 100\text{mV}$
	Ripple & noise	$\leq 1\text{mVrms}$ (5Hz-1MHz)
Resolution	Voltage Current	Voltage: programming 1mV ,readback 0.1mV Current: 0.1mA (T3PS13206: 0.2mA)
Accuracy	Ammeter	3.2A full scale (T3PS13206: 6.2A), programming 5 digits, readback 5 digits
	Voltmeter	33V full scale, programming 5 digits, readback 6 digits
	Setting accuracy	Voltage: $\pm (0.03\% \text{ of reading} + 10\text{mV})$ Current: $\pm (0.3\% \text{ of reading} + 10\text{mA})$
	Readback accuracy	Voltage: $\pm (0.03\% \text{ of reading} + 10\text{mV})$ Current: $\pm (0.3\% \text{ of reading} + 10\text{mA})$
Bindpost	Output voltage	1.8V/2.5V/3.3V/5.0V, $\pm 5\%$
	Output current	5A
CH3 (T3PS33203P)	Line regulation	$\leq 3\text{mV}$
	Load regulation	$\leq 5\text{mV}$
	Ripple & noise	$\leq 2\text{mVrms}$ (5Hz - 1MHz)
	Transient recovery time	$\leq 100\mu\text{s}$ (50% load change, minimum load 0.5A)
USB Port	Output	1.8V/2.5V/3.3V/5.0V, $\pm 0.35\text{V}$, 3A
 Warning	The output current from the 2 terminals should Not exceed 5A.	

Load Mode

Display	Voltage	1-33.00V
	Current	0-3.200A(T3PS13206:0-6.200A)
	Power	0-50.00(T3PS13206:0-100.00W)

CV Mode	CH1/CH2	1.500V - 33.00V
	Setting/ Readback accuracy	$\leq 0.1\% + 30\text{mV}$
	Resolution	10mV
CC Mode	CH1/CH2	0 ~ 3.200A 0 ~ 6.200A(T3PS13206)
	Setting/Readba ck accuracy	$\leq \pm 0.3\% + 10\text{mA}$
	Resolution	1mA
CR Mode	CH1/CH2	$1\Omega \sim 1\text{k}\Omega$
	Setting/ Readback accuracy	$\leq \pm(3\% + 1\Omega)$ (voltage $\geq 0.1\text{V}$, and current $\geq 0.1\text{A}$)
	Resolution	1Ω

Other Mode

OVP	Power mode	OFF, ON(0.5V- 35.0V) (CH1/CH2) OFF, ON(0.5V- 5.5V) (T3PS43203P: CH3) OFF, ON(0.5V- 16.5V) (T3PS43203P: CH4) Fixed 5.5V (T3PS33203P:CH3)
	Load mode	OFF, ON(1.5V - 35.0V) (CH1/CH2)
	Setting accuray	$\pm 100\text{mV}$
	Resolution	100mV
OCP	Power/Load mode	OFF, ON(0.05A-7.00A) (T3PS13206) OFF, ON(0.05A-3.50A) (CH1/CH2) OFF, ON(0.05A-1.20A) (T3PS43203P:CH3/CH4) 3.1A (USB port) (T3PS33203P:CH3)
	Setting accuracy	$\pm 20\text{mA}$
	Resolution	10mA
Insulation resistance	Between chassis and terminal	$20\text{M}\Omega$ or above (DC 500V)

Between 30M Ω or above (DC 500V)
chassis and DC
power cord



Company Profile

Teledyne LeCroy is a leading provider of oscilloscopes, protocol analyzers and related test and measurement solutions that enable companies across a wide range of industries to design and test electronic devices of all types. Since our founding in 1964, we have focused on creating products that improve productivity by helping engineers resolve design issues faster and more effectively. Oscilloscopes are tools used by designers and engineers to measure and analyze complex electronic signals in order to develop high-performance systems and to validate electronic designs in order to improve time to market.

The Teledyne Test Tools brand extends the Teledyne LeCroy product portfolio with a comprehensive range of test equipment solutions. This new range of products delivers a broad range of quality test solutions that enable engineers to rapidly validate product and design and reduce time-to-market. Designers, engineers and educators rely on Teledyne Test Tools solutions to meet their most challenging needs for testing, education and electronics validation.

Location and Facilities

Headquartered in Chestnut Ridge, New York, Teledyne Test Tools and Teledyne LeCroy has sales, service and development subsidiaries in the US and throughout Europe and Asia. Teledyne Test Tools and Teledyne LeCroy products are employed across a wide variety of industries, including semiconductor, computer, consumer electronics, education, military/aerospace, automotive/industrial, and telecommunications.

Distributed by:

Teledyne LeCroy (US Headquarters)

700 Chestnut Ridge Road
Chestnut Ridge, NY. USA 10977-6499

Phone: 800-553-2769 or 845-425-2000
Fax Sales: 845-578-5985
Phone Support: 1-800-553-2769
Email Sales: contact.corp@teledynelecroy.com
Email Support: support@teledynelecroy.com
Web Site: <http://teledynelecroy.com/>

World wide support contacts can be found at:
<https://teledynelecroy.com/support/contact>

World wide instrument service can be found at:
<https://teledynelecroy.com/support/service.aspx>

RoHS and WEEE information can be found at:
<https://teledynelecroy.com/support/rohs.aspx>

teledynelecroy.com

© 2018 Teledyne Test Tools is a brand and trademark of Teledyne LeCroy Inc. All rights reserved. Specifications, prices, availability and delivery subject to change without notice. Product brand or brand names are trademarks or requested trademarks of their respective holders.

T3 stands for Teledyne Test Tools.

